

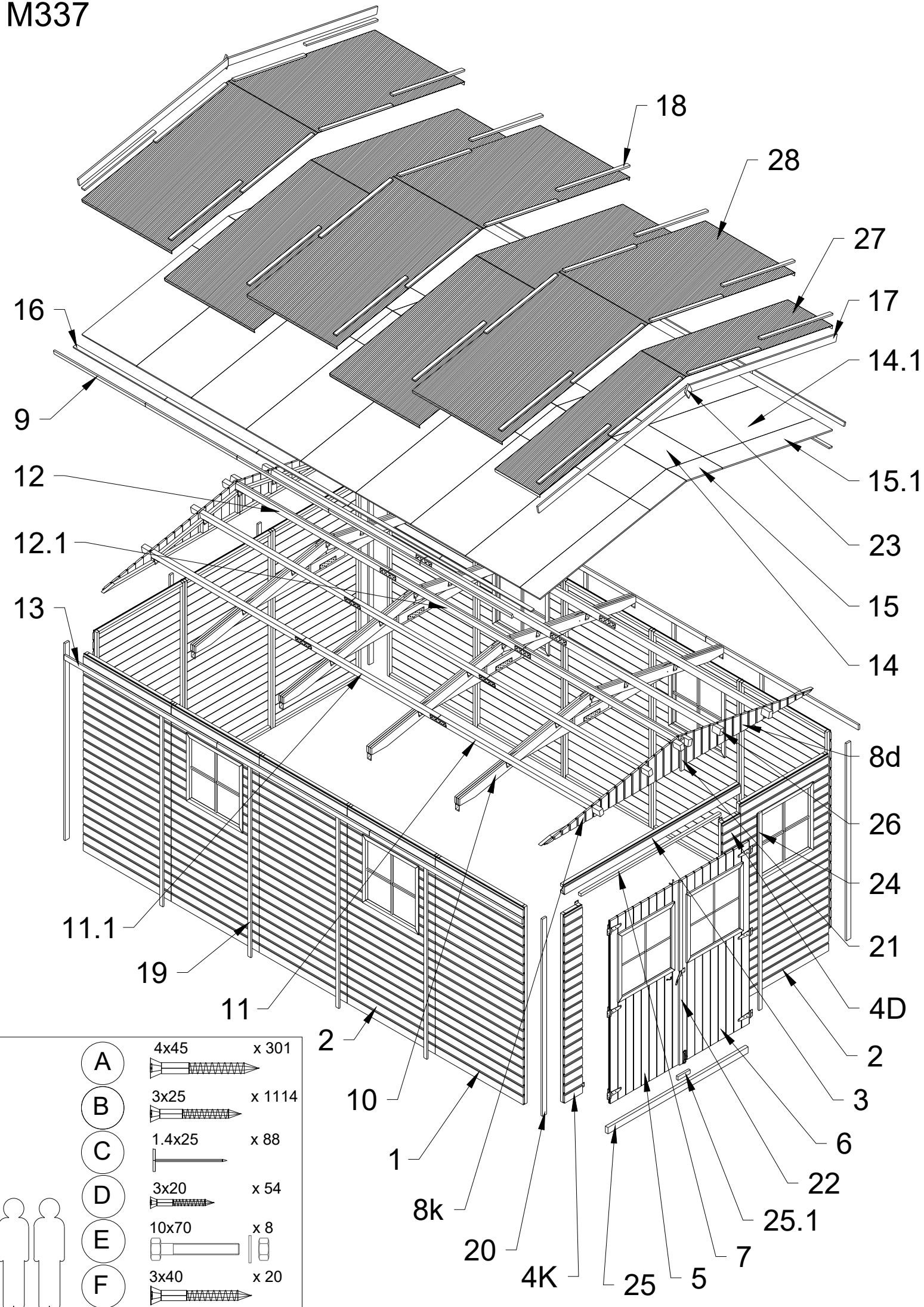

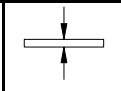

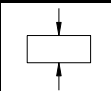

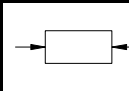

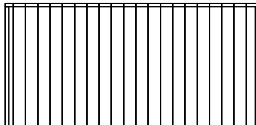
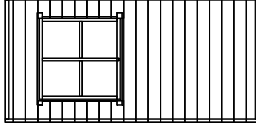
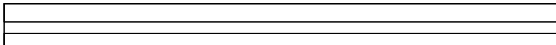
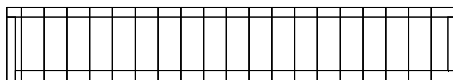
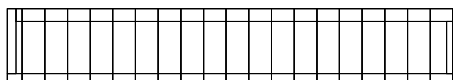
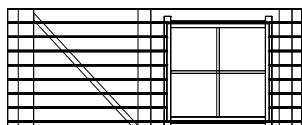
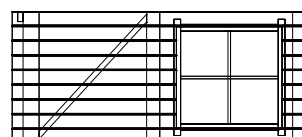
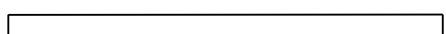
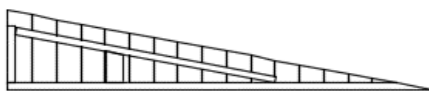
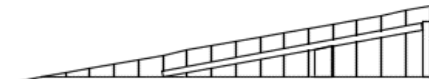

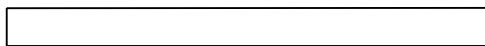
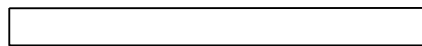

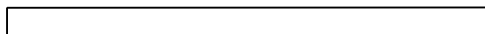



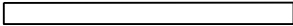
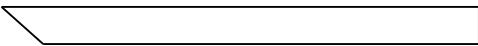

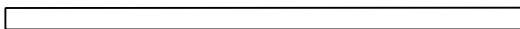
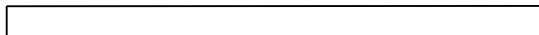

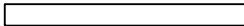

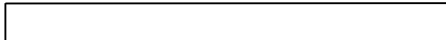
M337

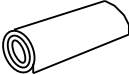

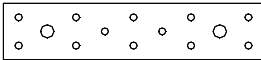
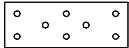
№		PCS			
			mm	mm	mm
1		9		980	1900
2		5		980	1900
3		1		89	1960
4K		1		200	1814
4D		1		200	1814
5		1		770	1760
6		1		770	1760
7		1	25	30	1560
8K		2		302	1517
8D		2		302	1517
9		10	15	35	1020
10		8		354	1660
11		8	40	60	1700
11.1		4	40	60	1500
12		2	40	60	1700
12.1		1	40	60	1500
13		6	17	47	1700

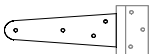
14		16	OSB	410	610
14.1		16	OSB	610	1250
15		2	OSB	220	410
15.1		2	OSB	220	1250
16		10	OSB	35	1020
17		4	15	69	1700
18		28	15	35	813
19		8	15	35	1835
20		4	17	47	1900
21		2	15	35	298
22		2	15	35	855
23		2	15	75	145
24		3	15	35	1900
25		1	30	60	1560
25.1		1	19	35	135
26		12	40	60	84
27		1		0,5m	3,47m
28		5		1 m	3,47m
29		28			
30		9			
31		38			
32		6			
33		3			
34		1			

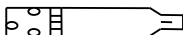
1

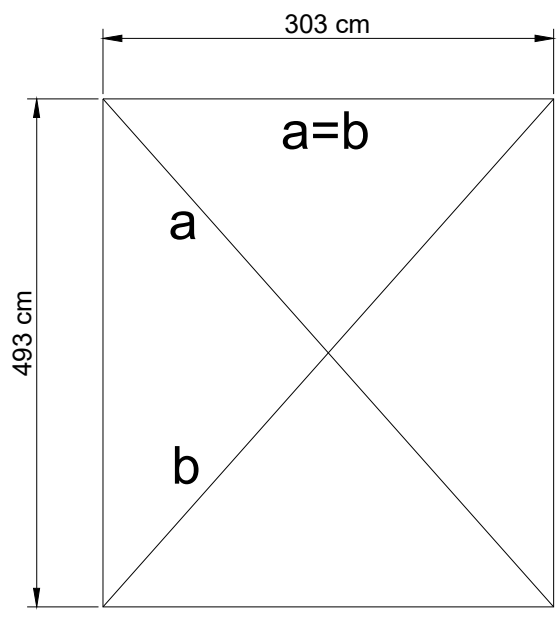
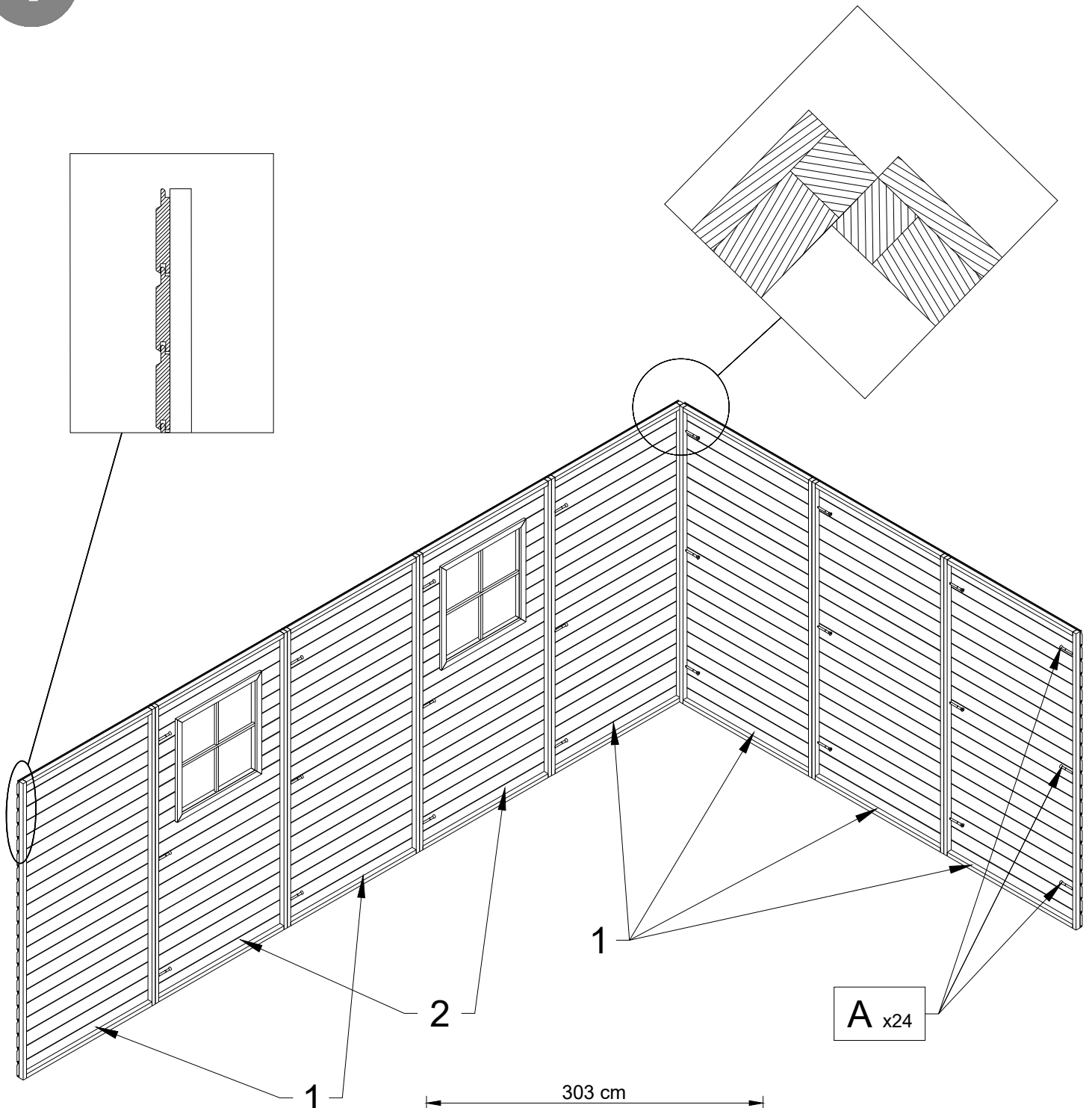

2

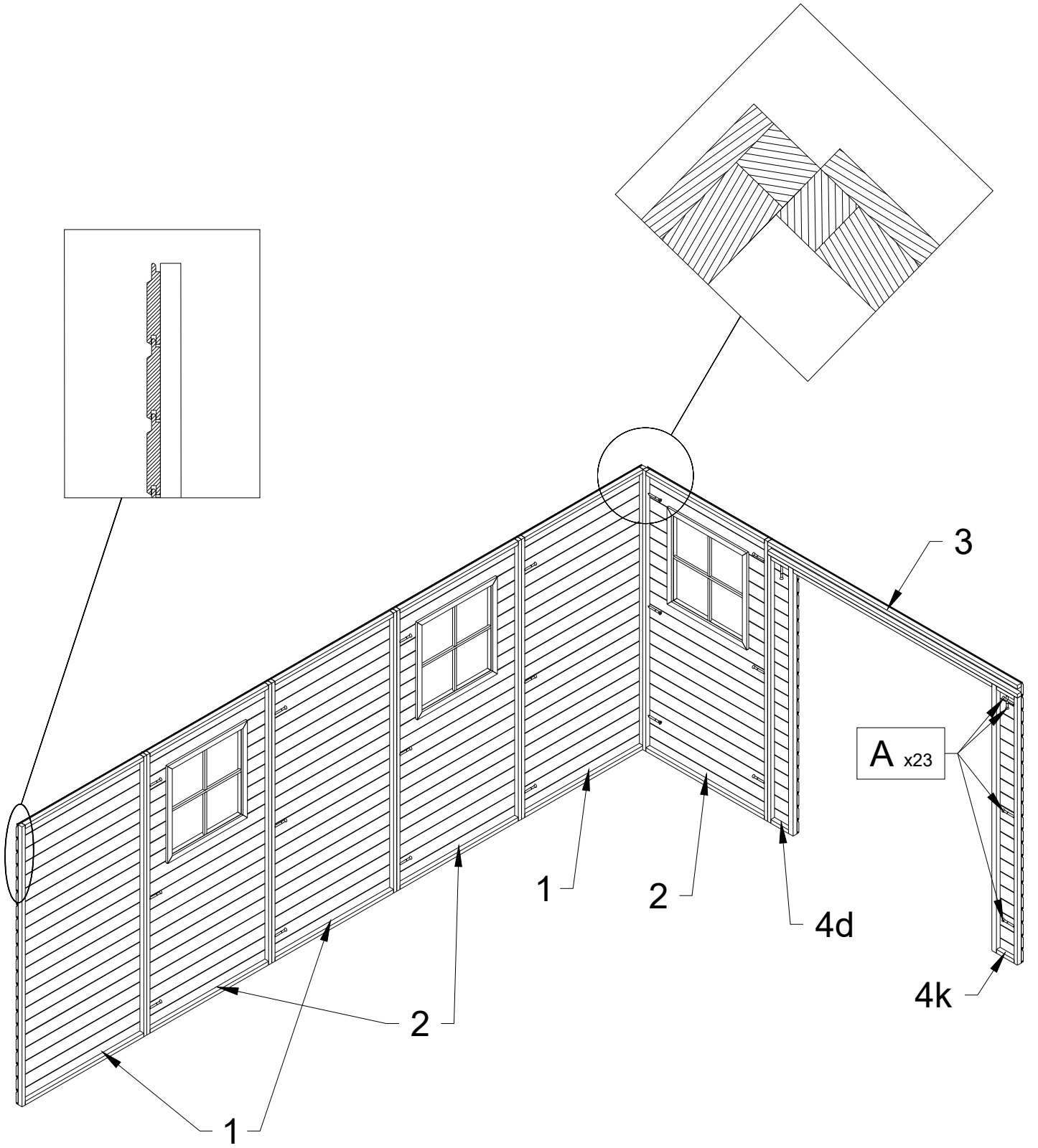

3

A x8

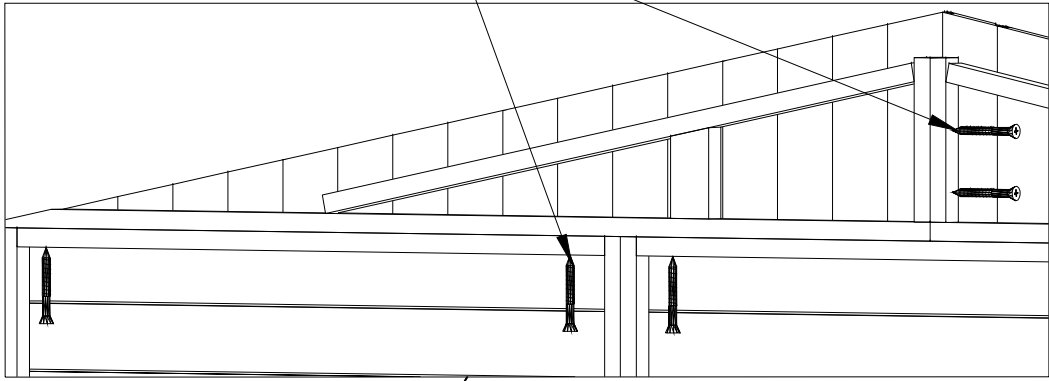

8D

8K

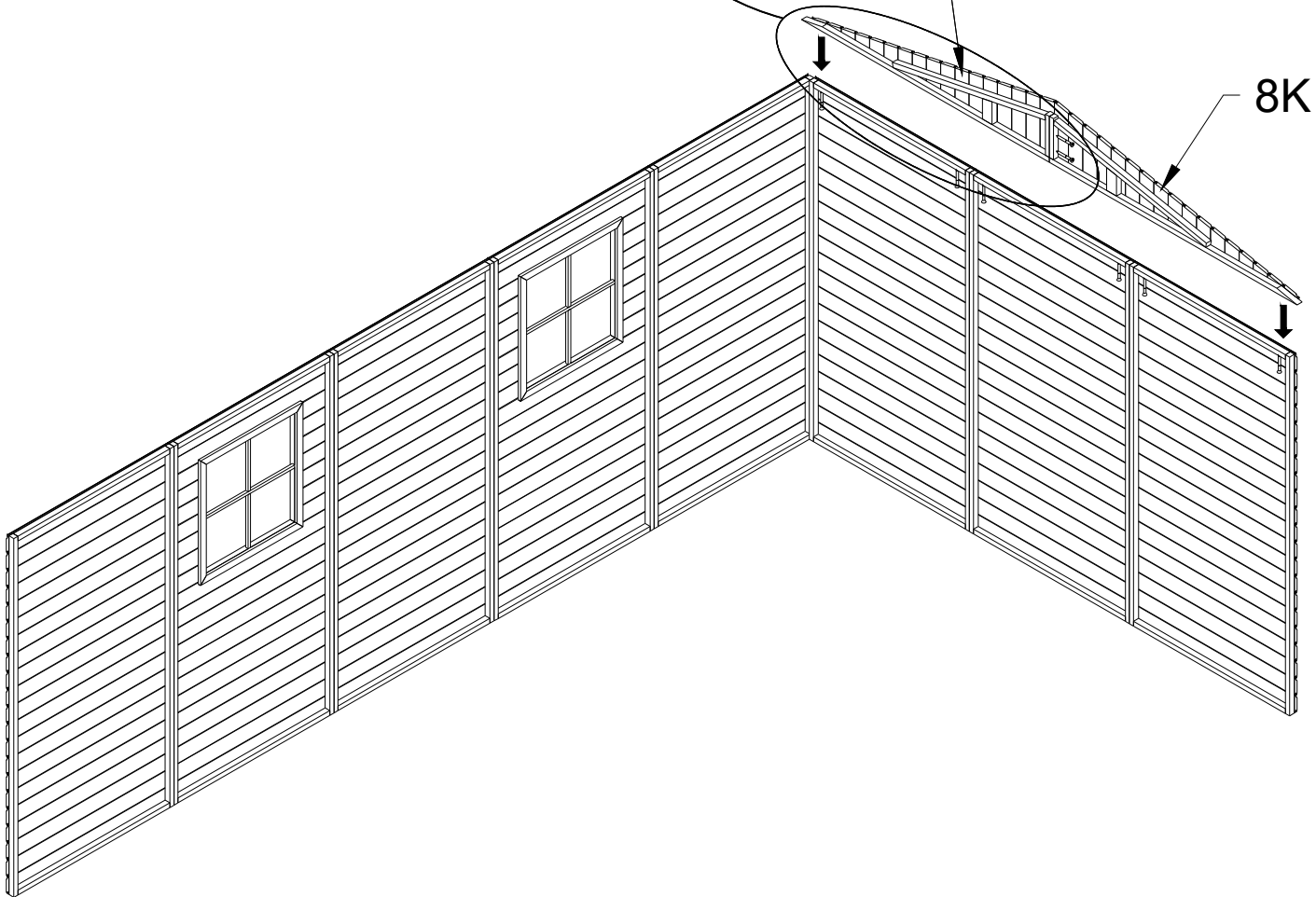

4

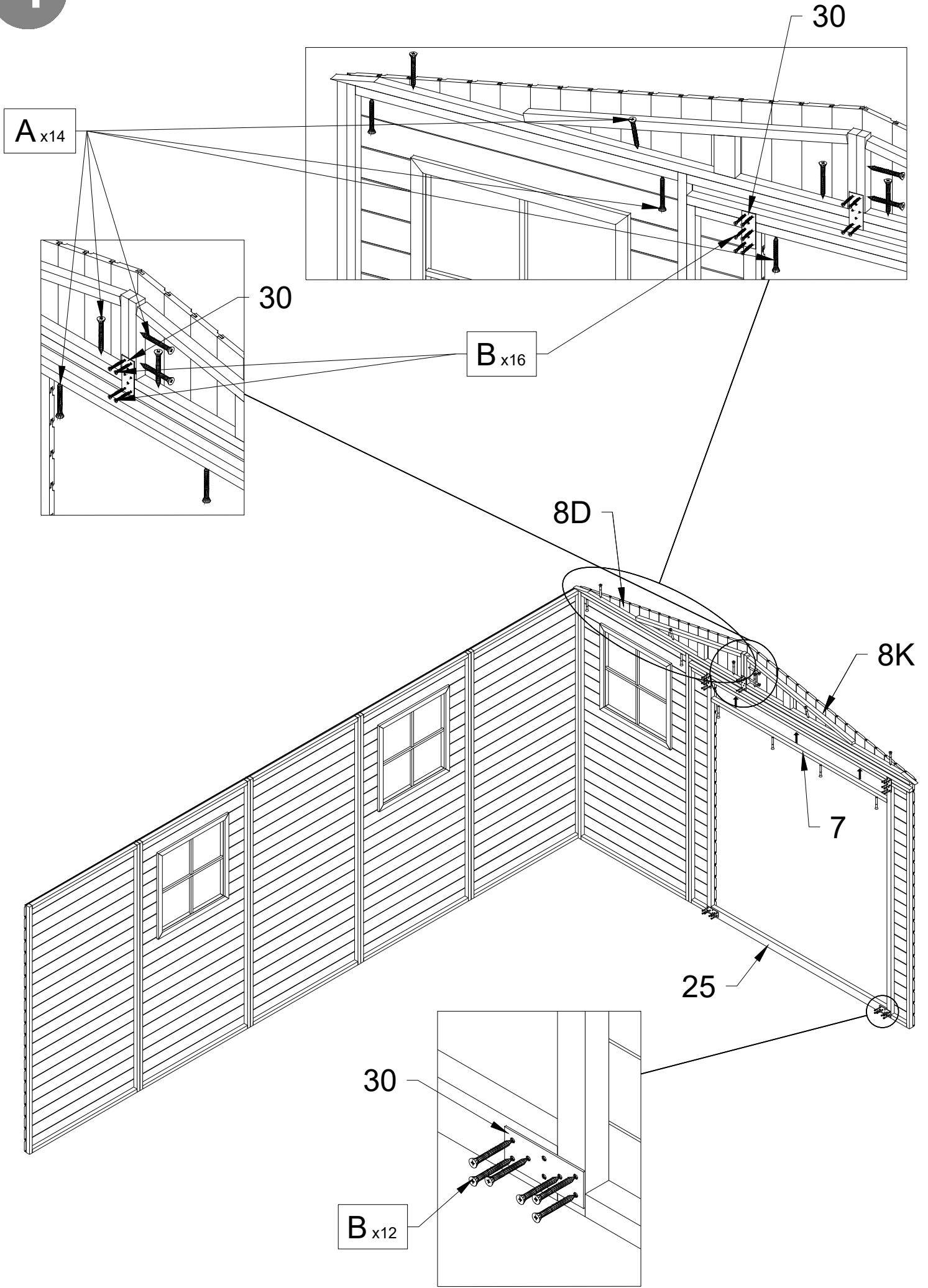

5

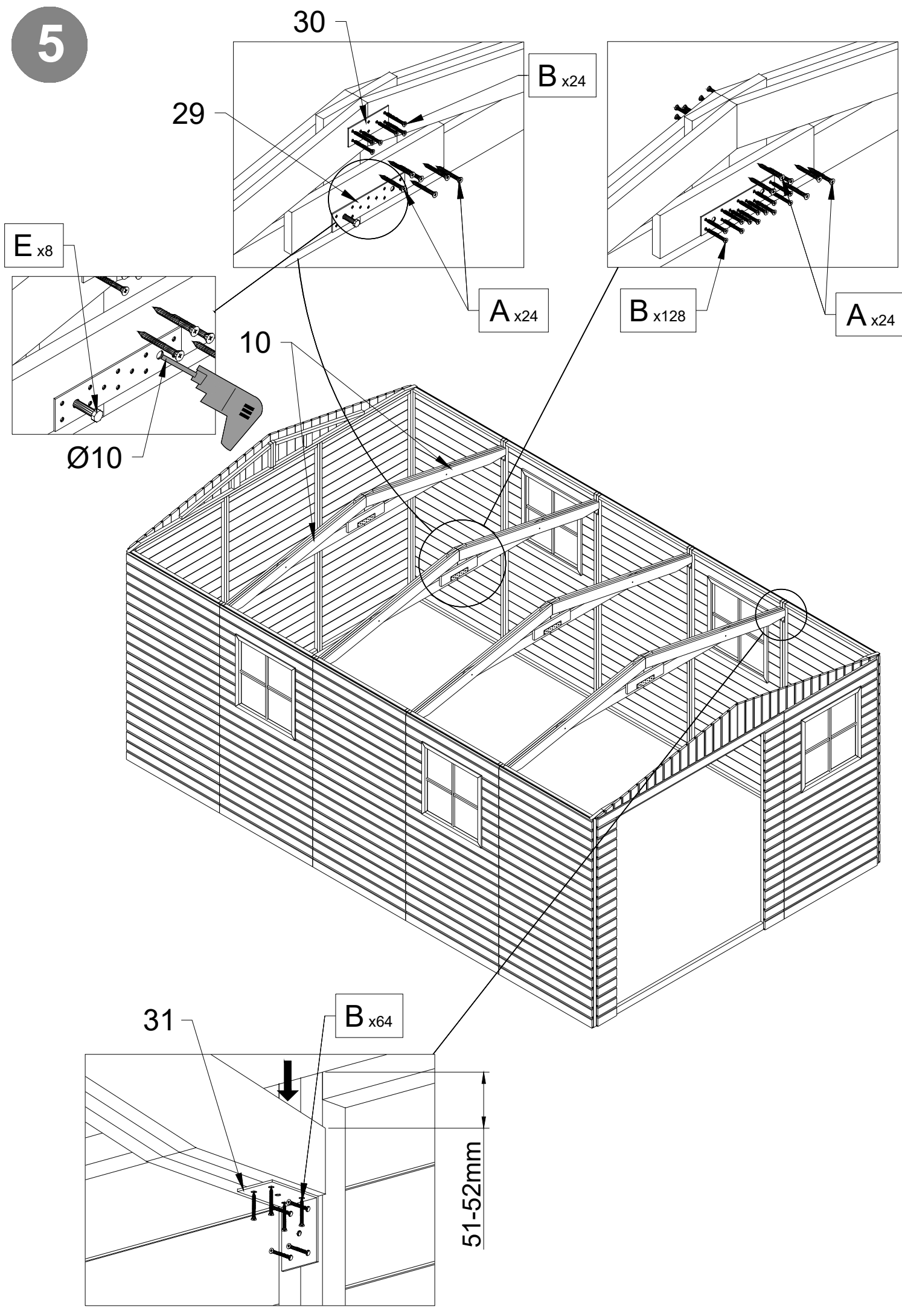

6

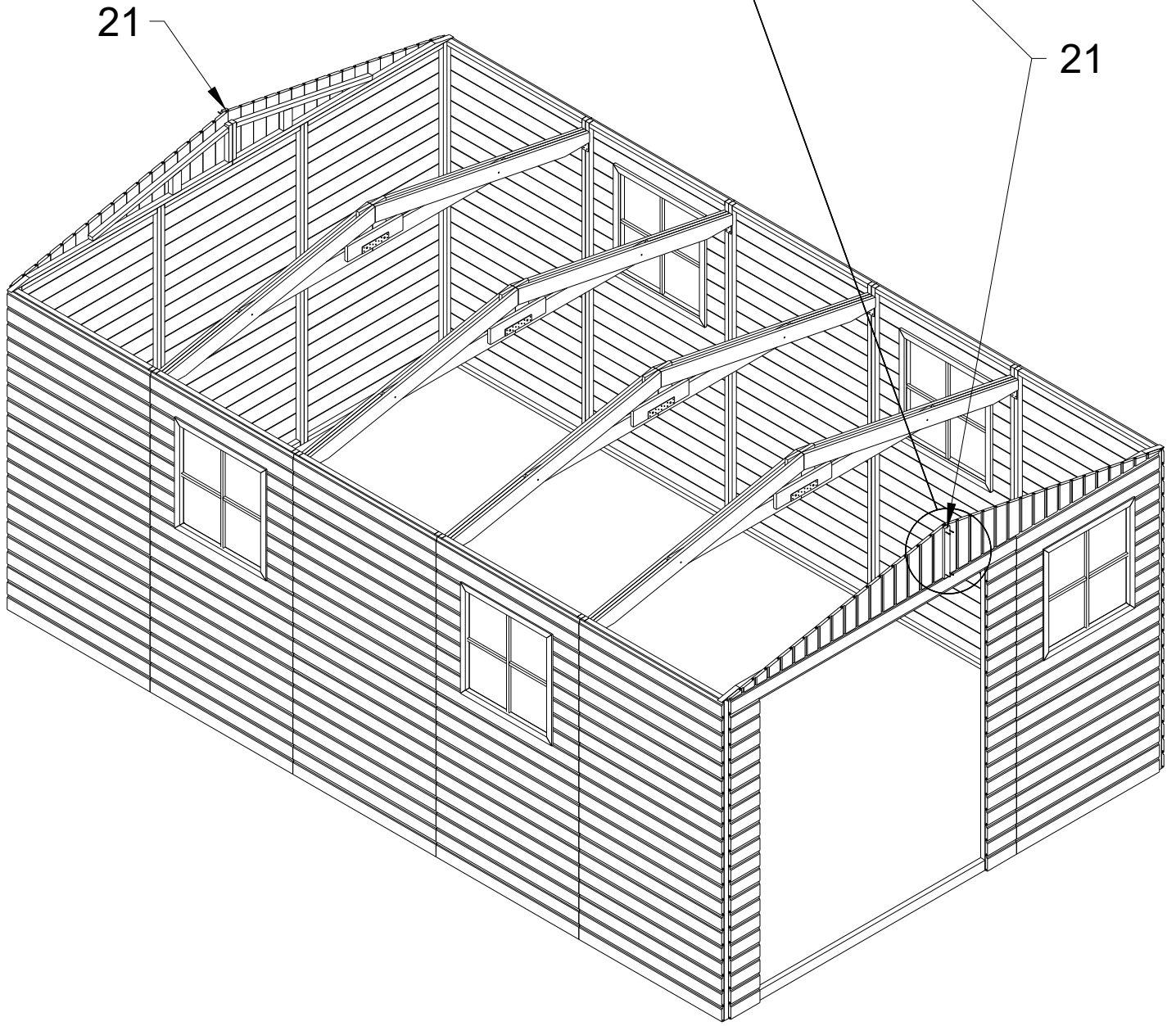
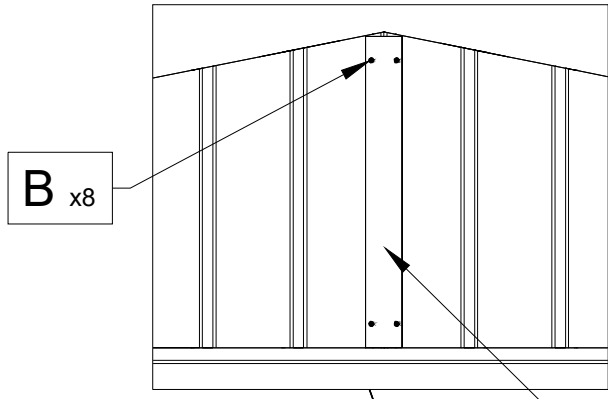

7

26

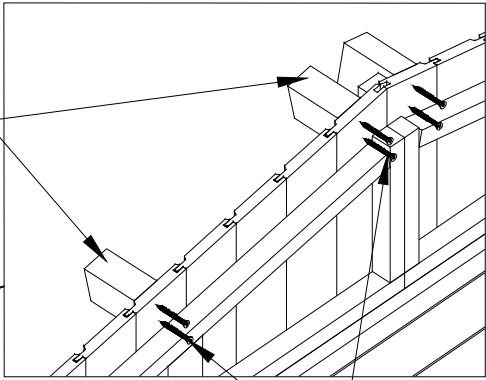

A x24

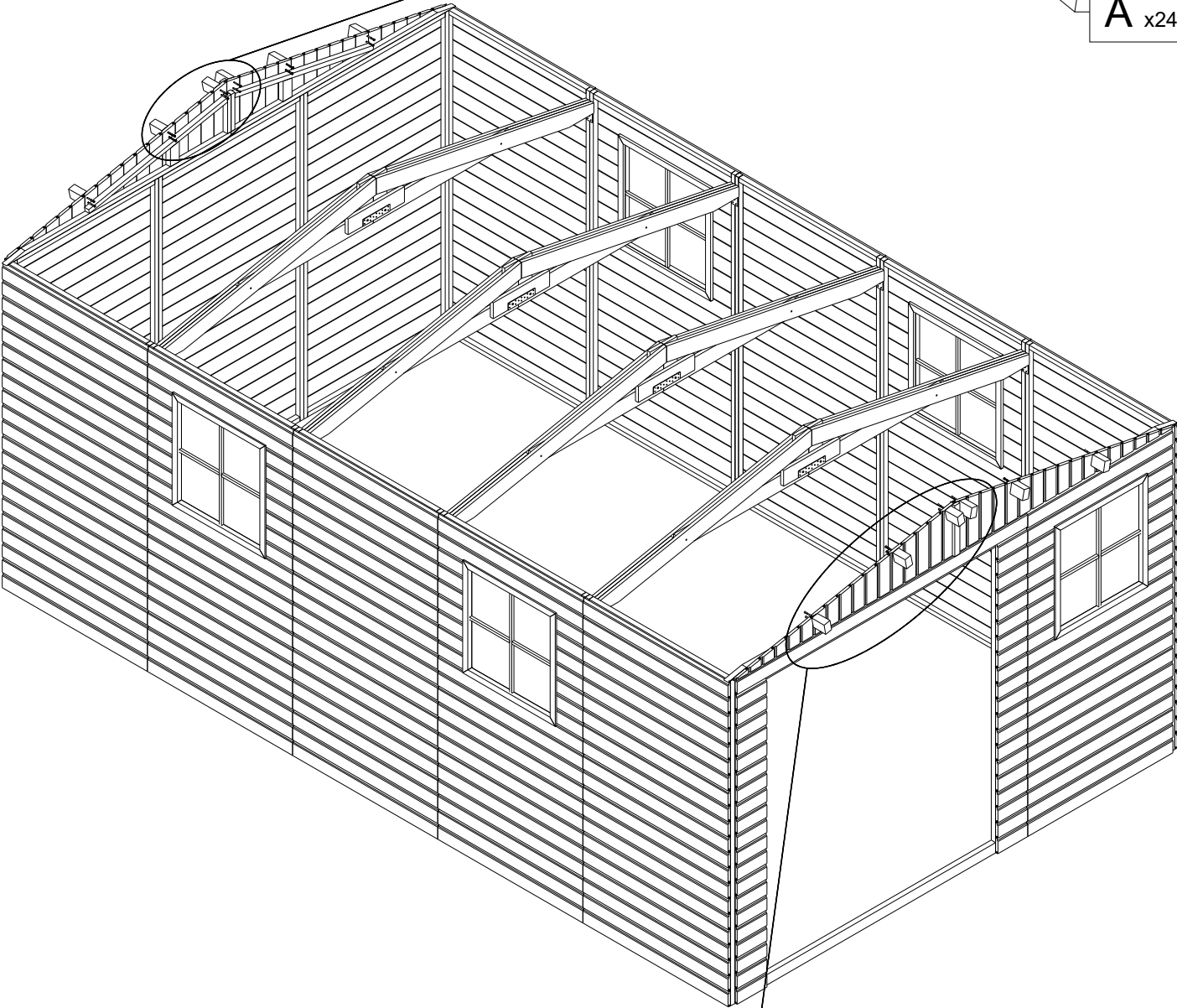

26

40

390

30

40

517

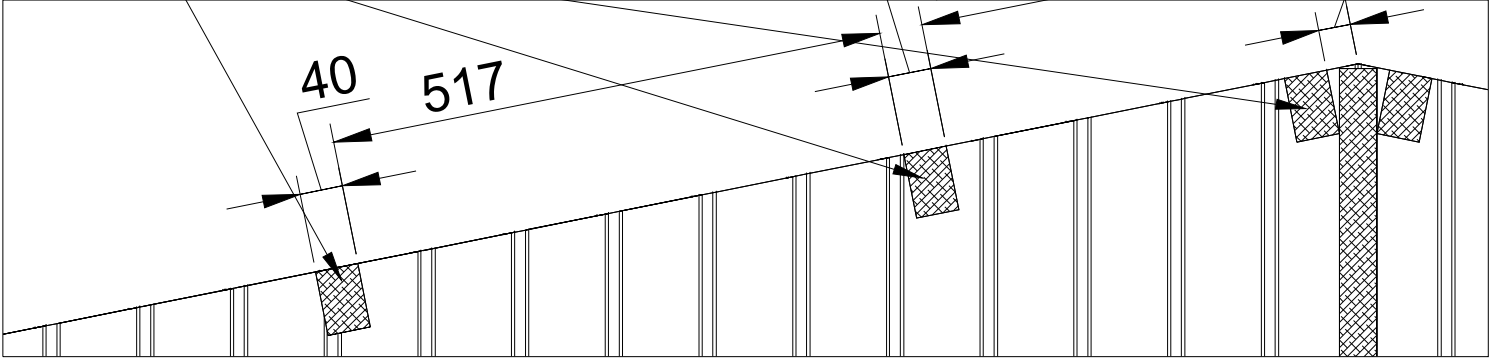

8

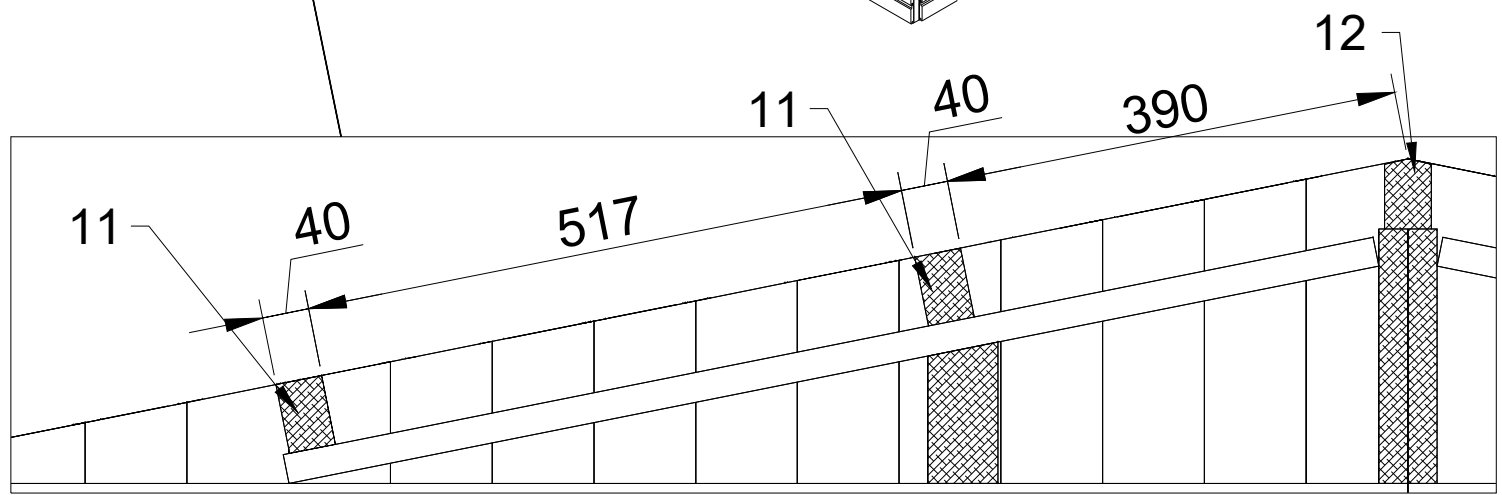
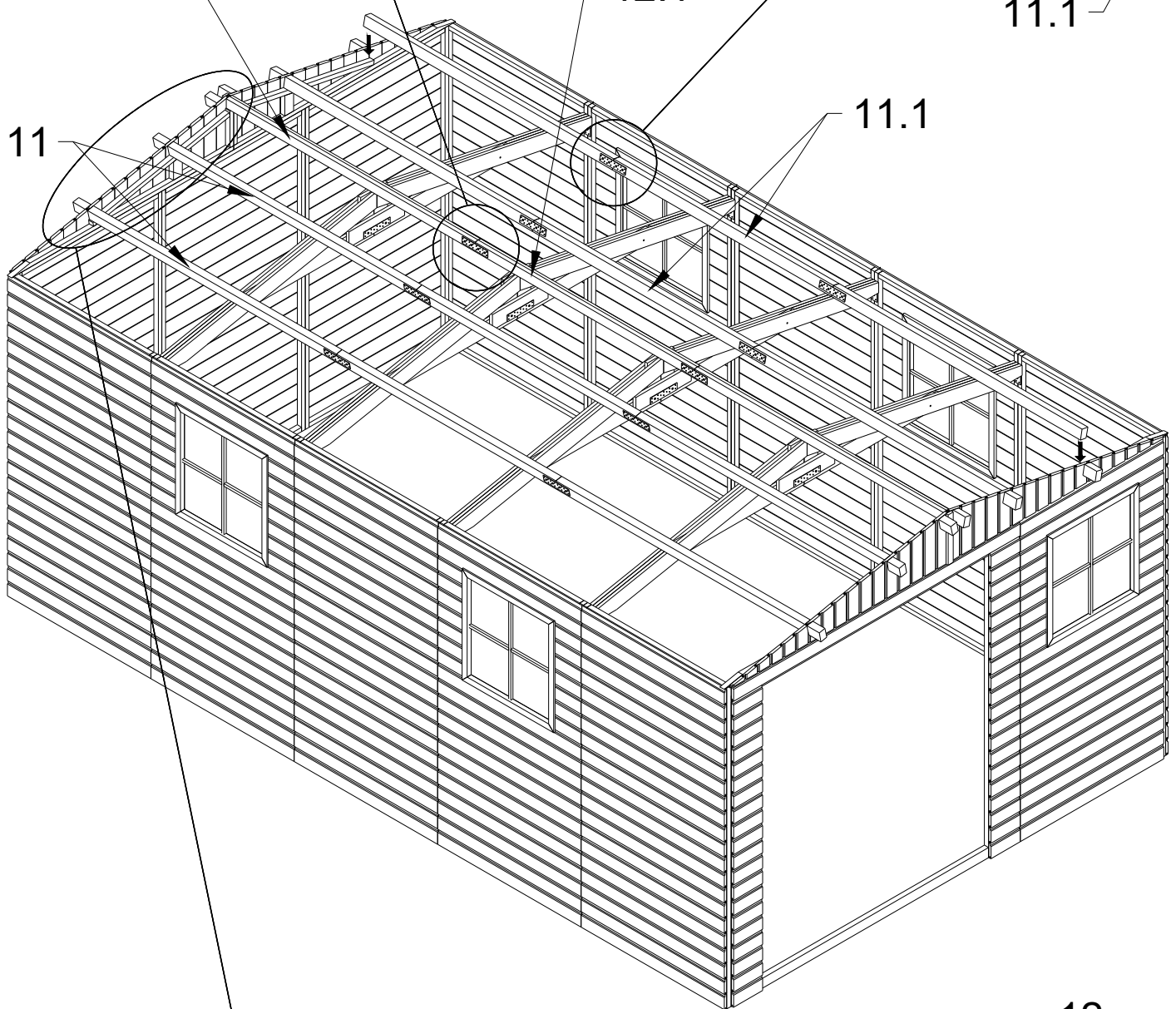
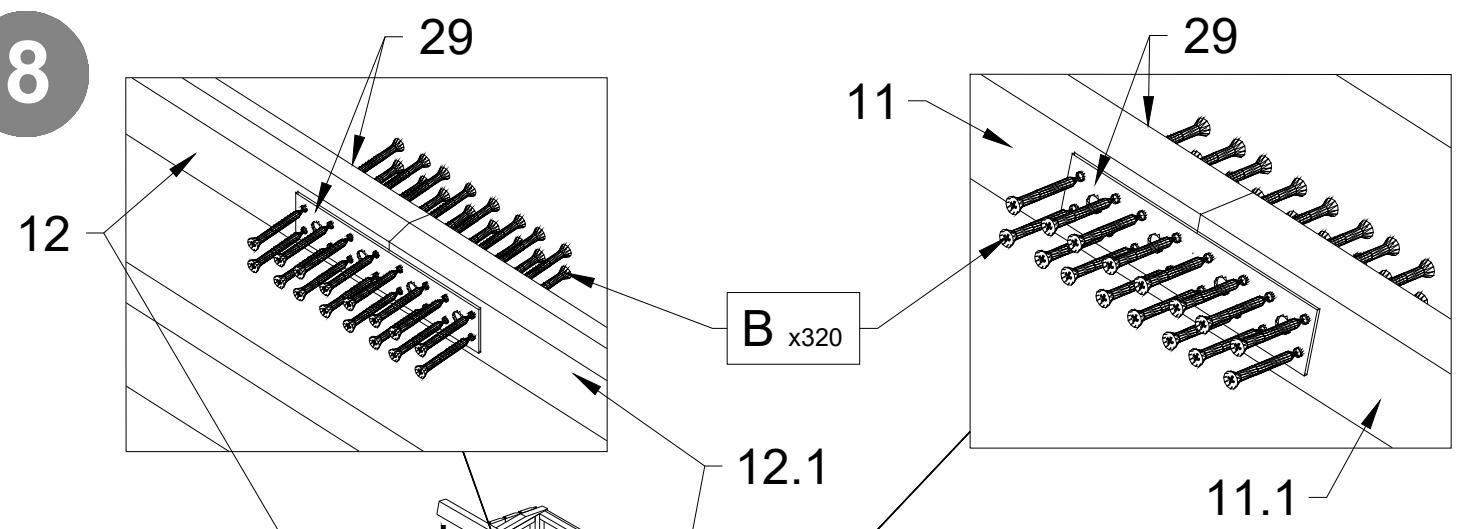

9

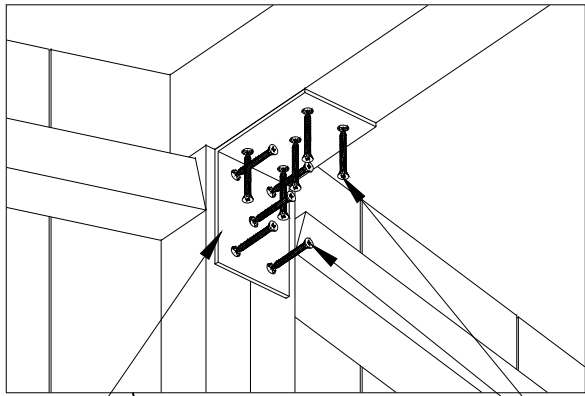

31

B x20

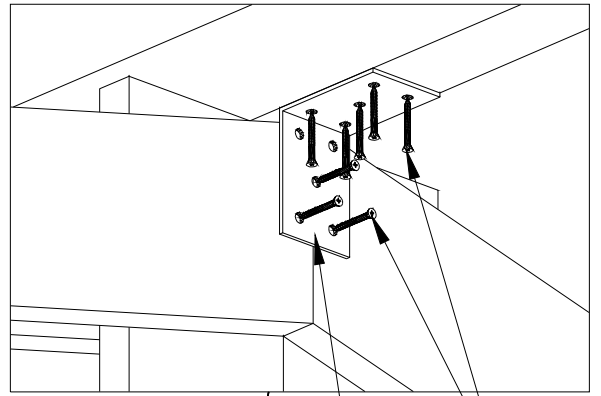

31

B x32

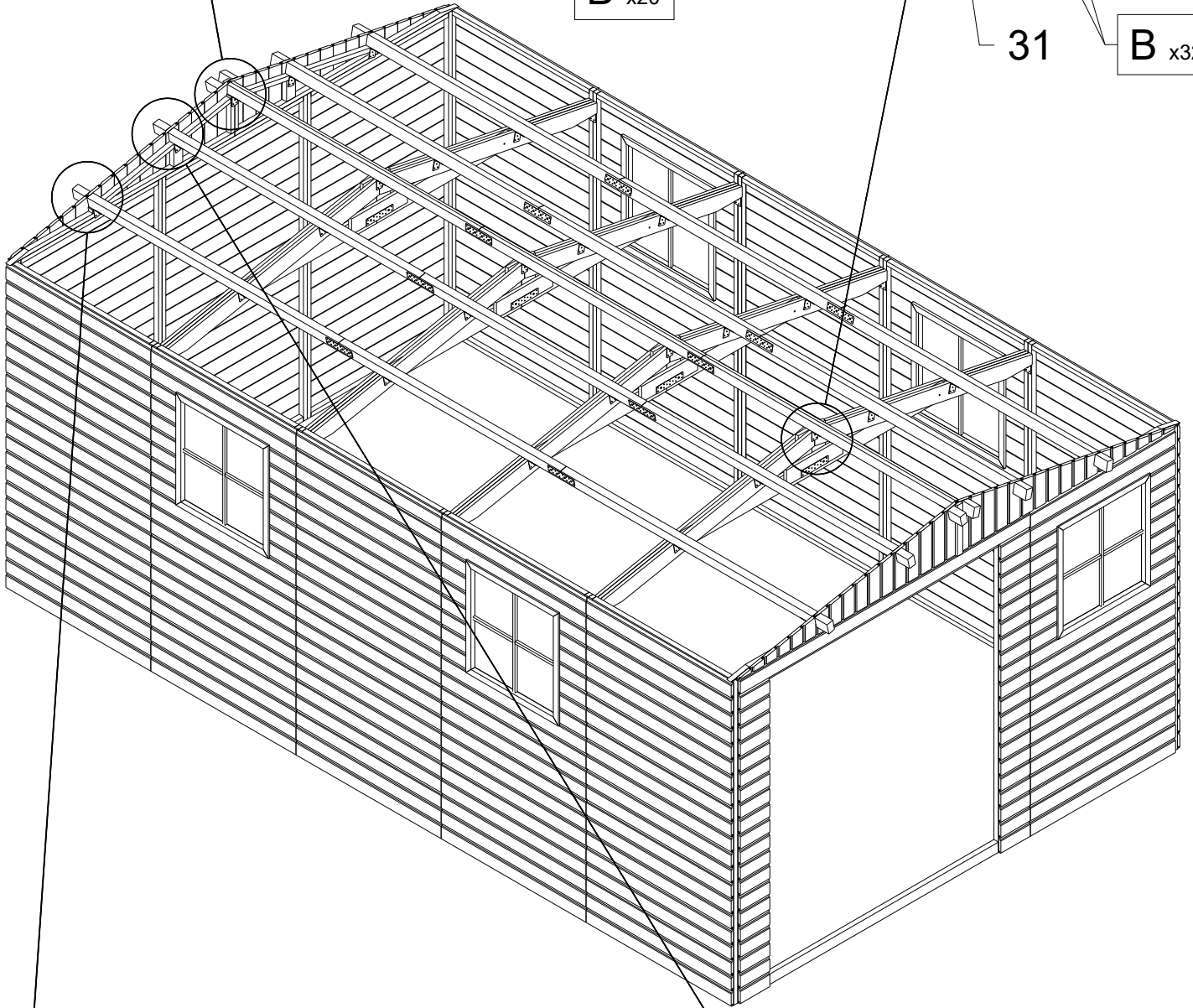

31

B x236

31

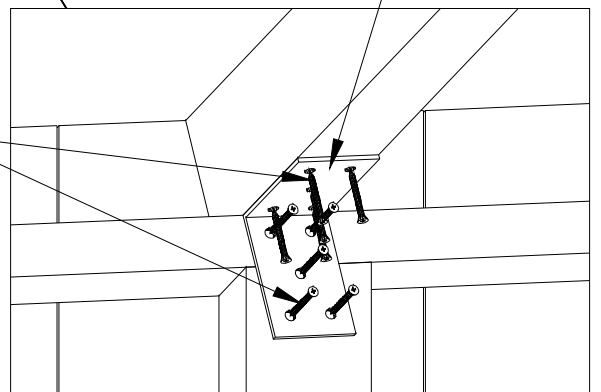
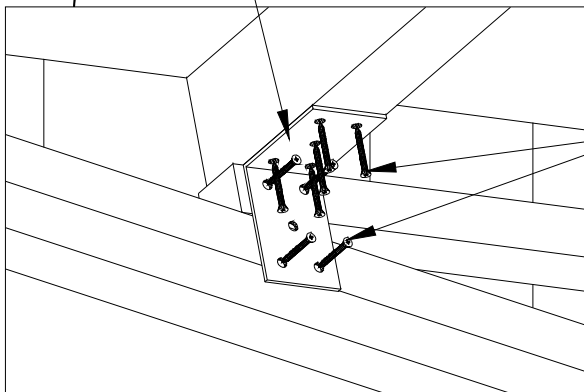

10

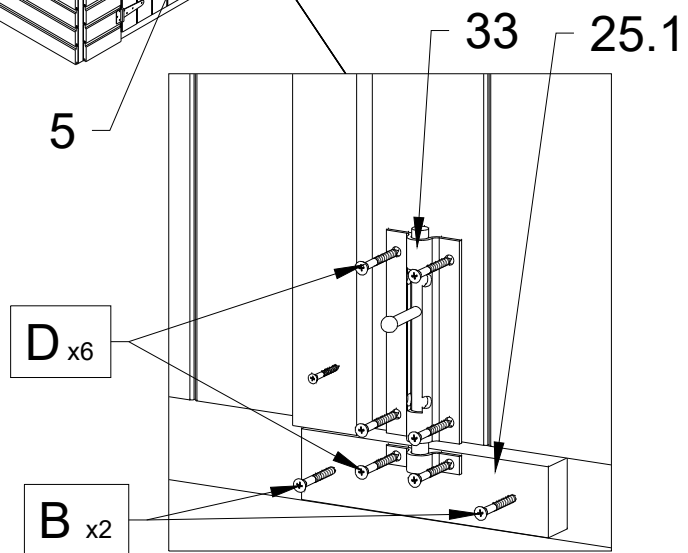
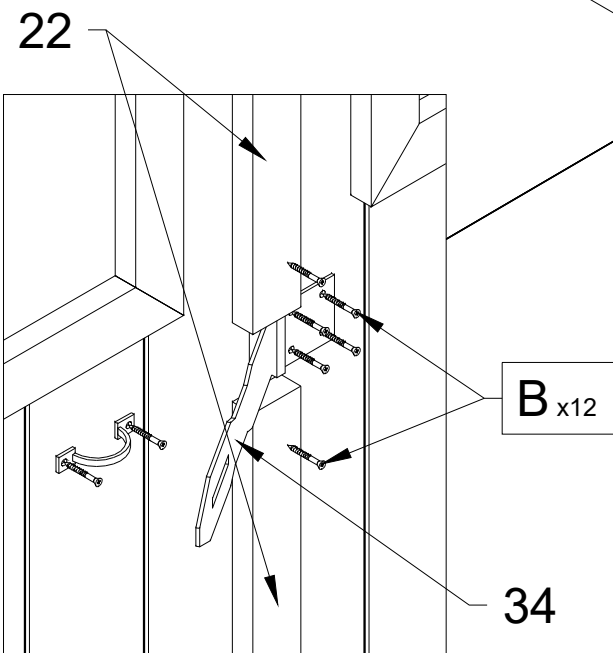
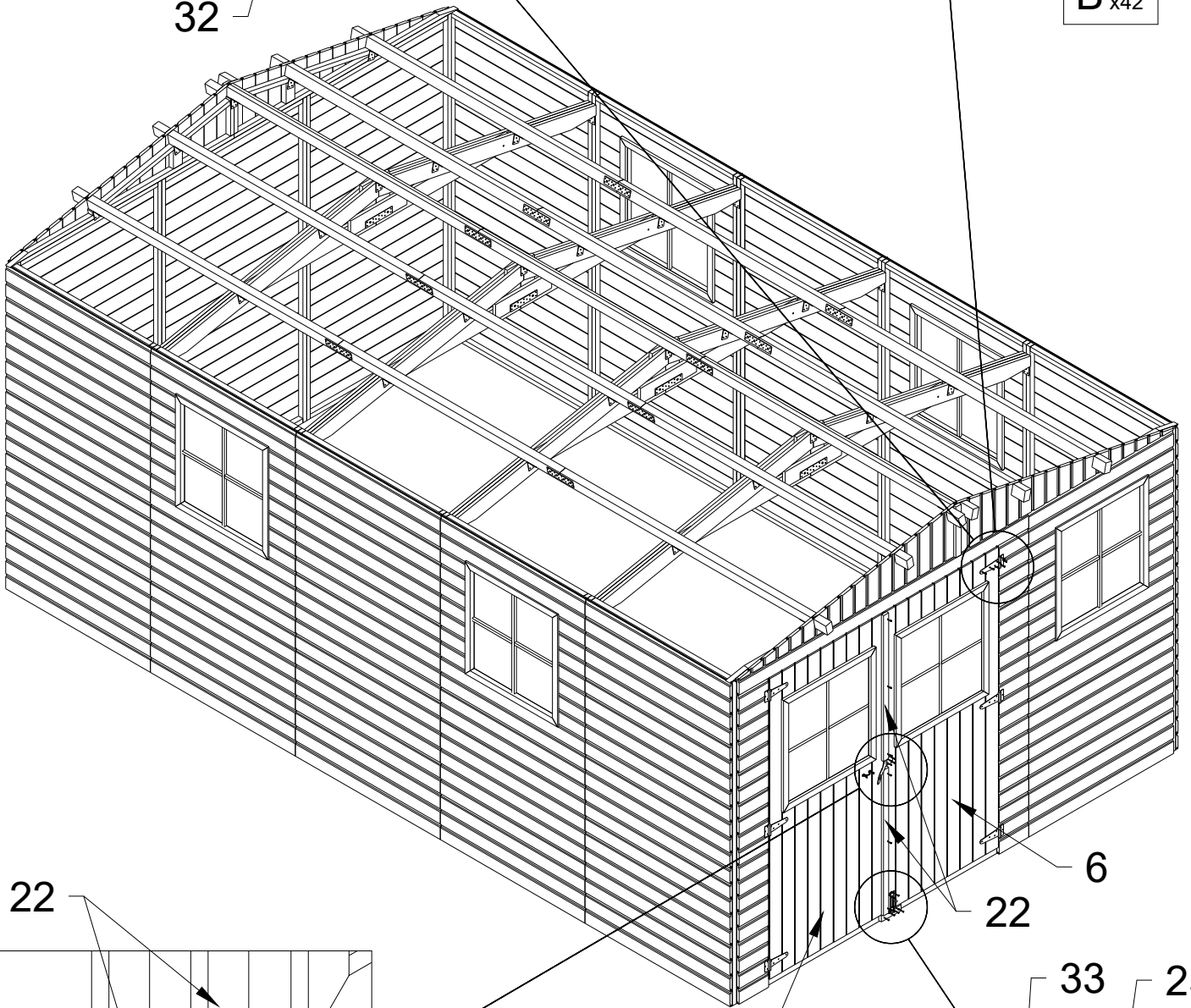
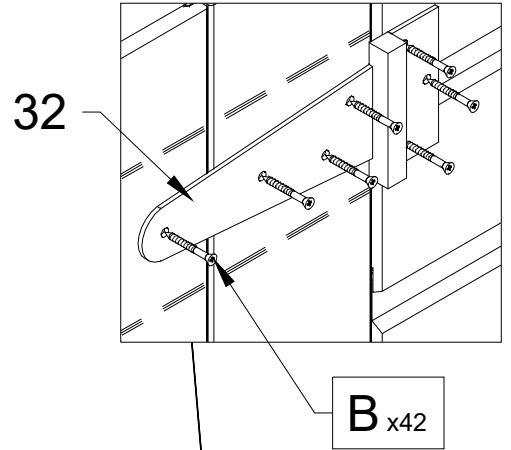
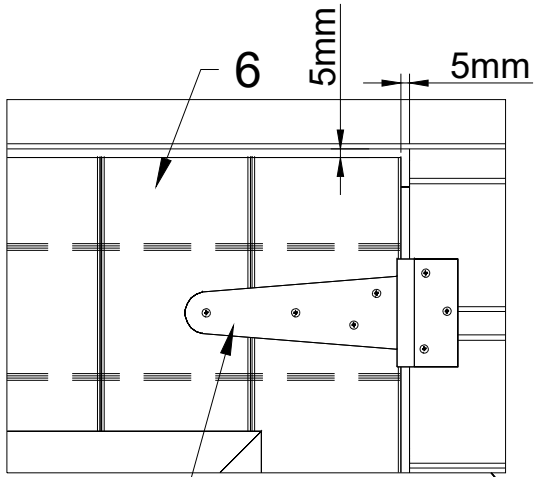

B x8

33

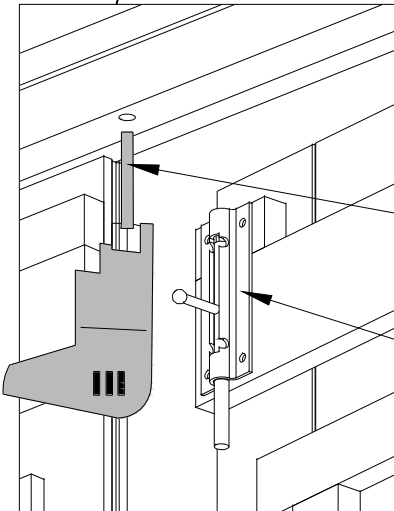
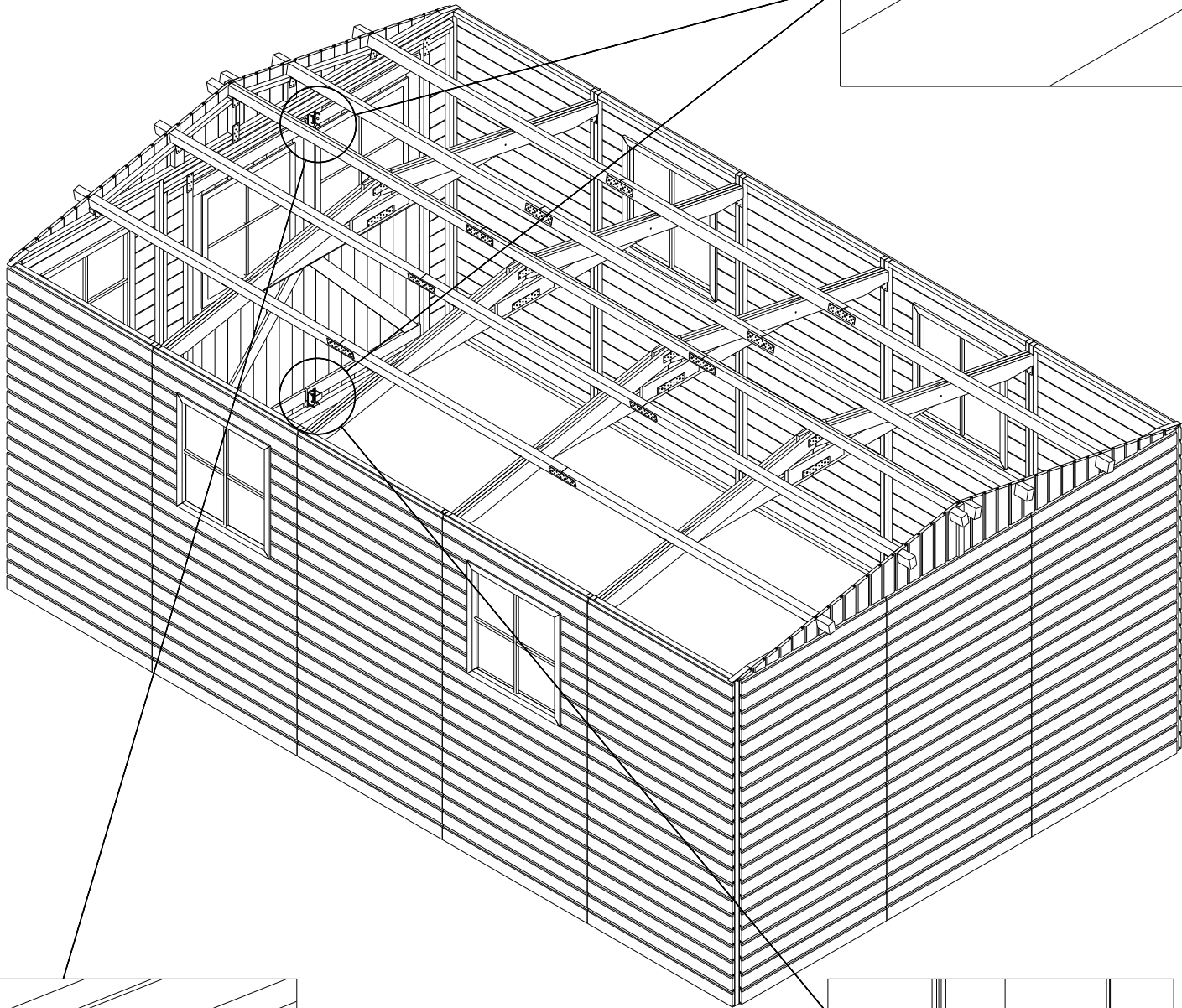
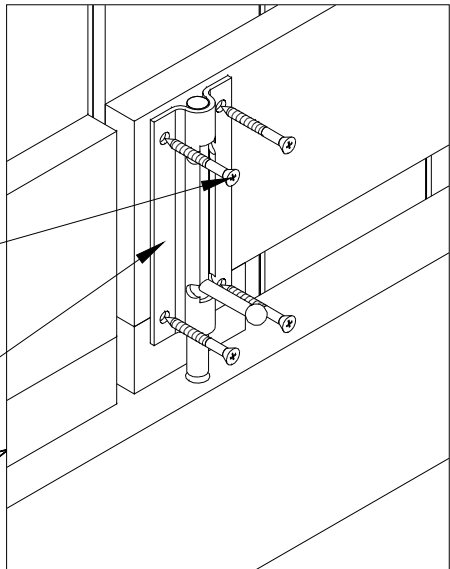

Ø12mm

33

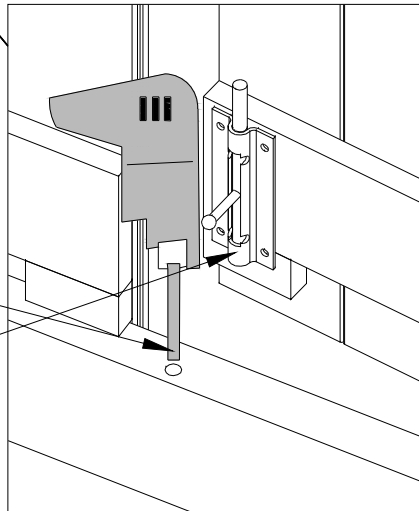

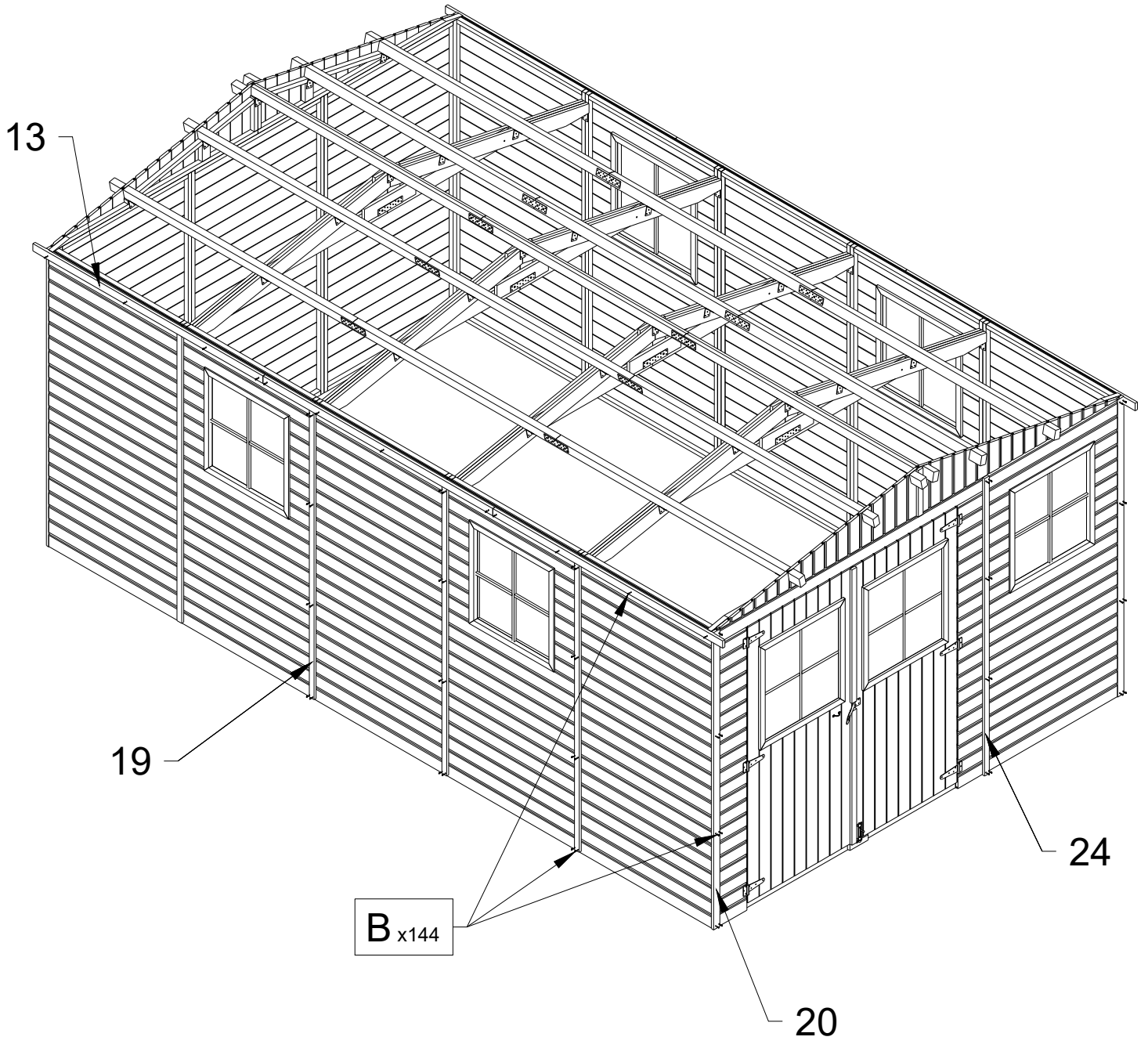

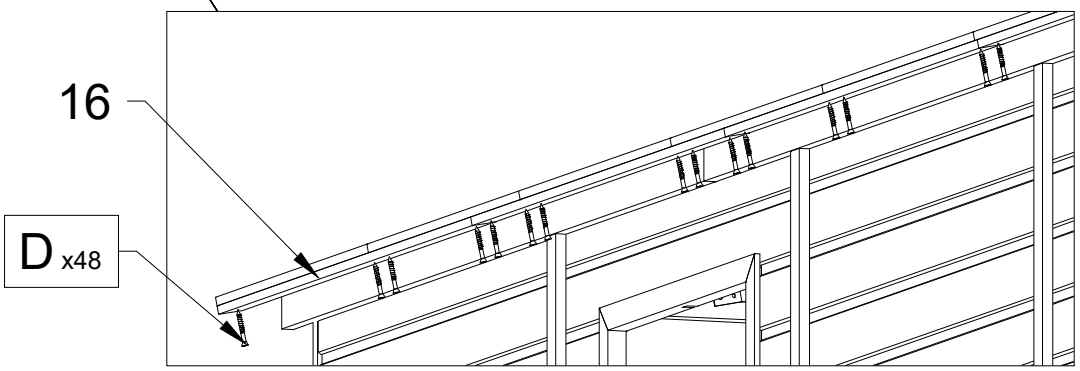
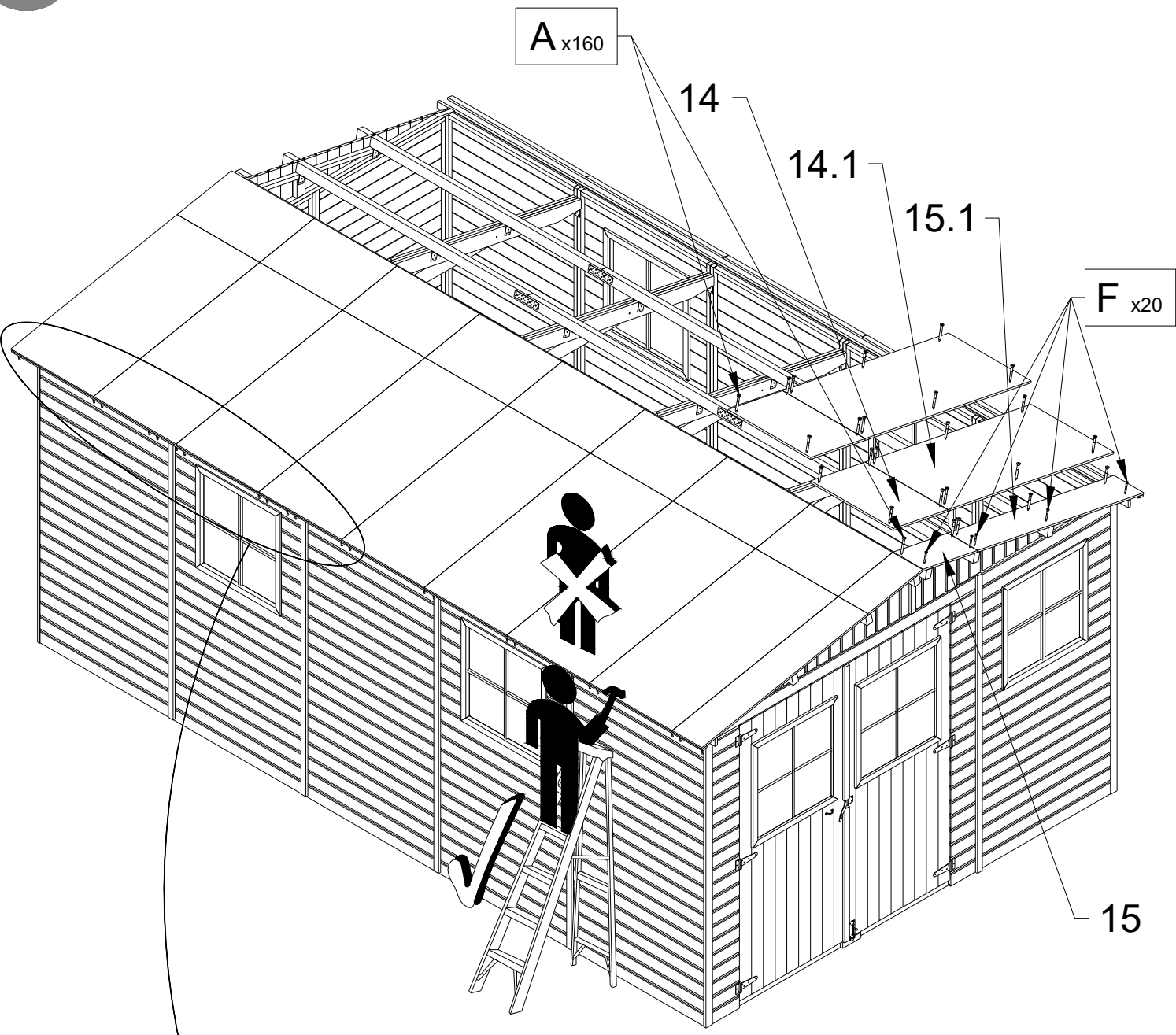

14



MAX
30 kg/m²

C x84

18

27

28

B x30

9

23

C x4

B x16

17

