

DE
FR
ENG

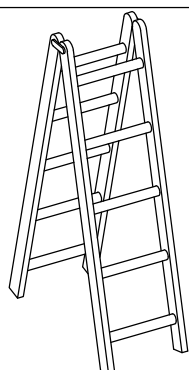

Ø4

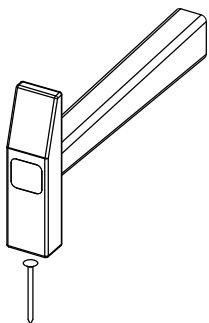

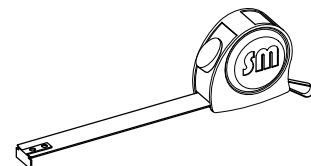
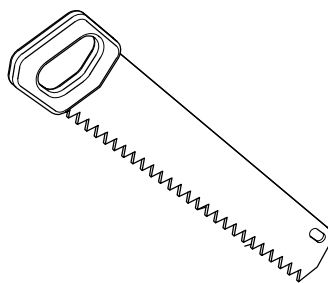
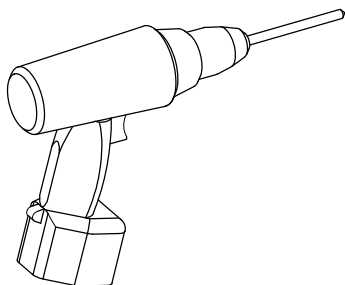
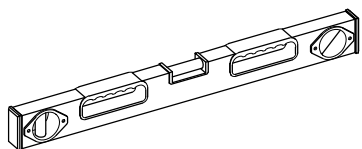
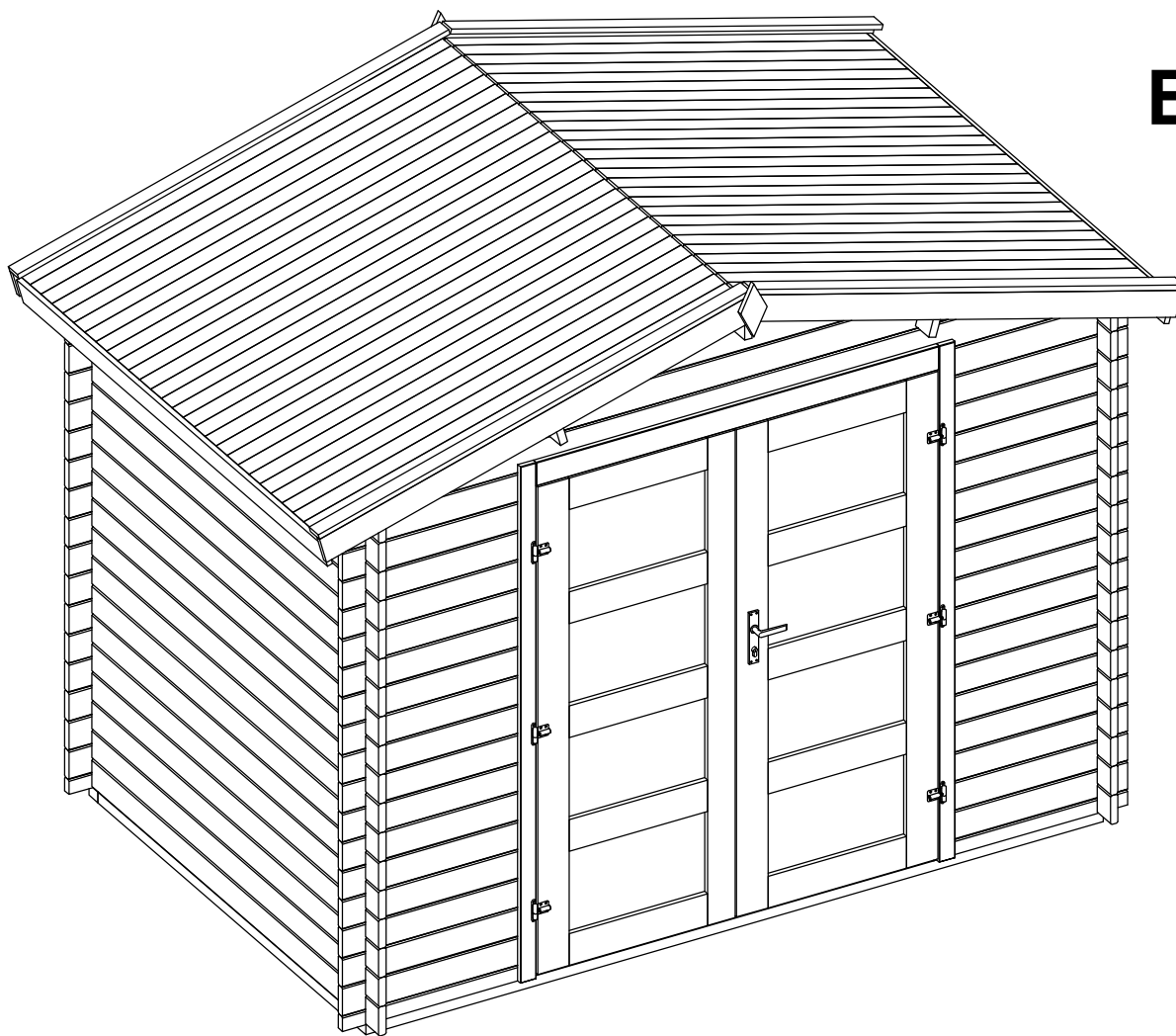
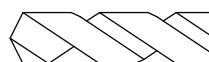

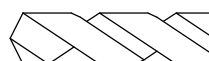



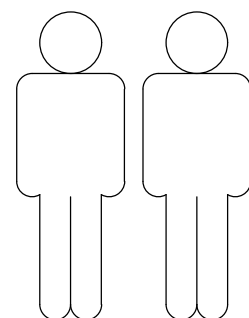
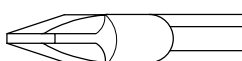

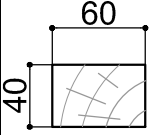

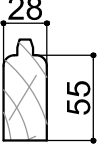
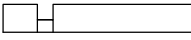
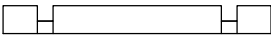
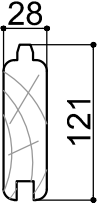
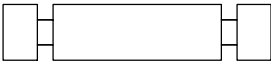
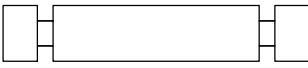
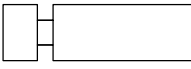
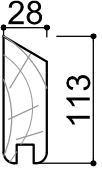
Ø5

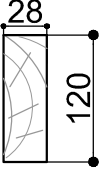
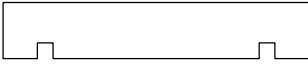
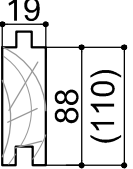

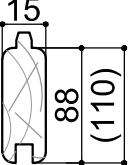
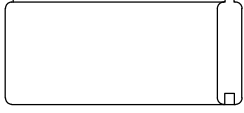

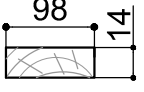
Ø10

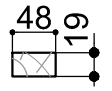
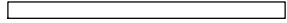
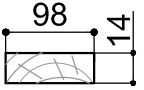

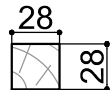
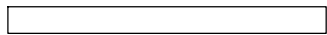
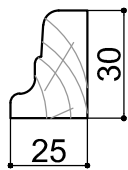
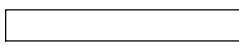
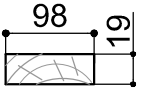
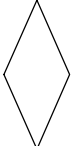
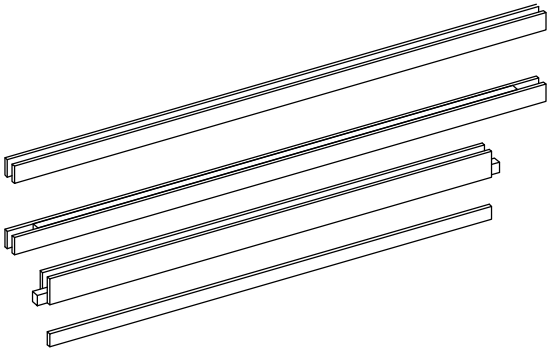
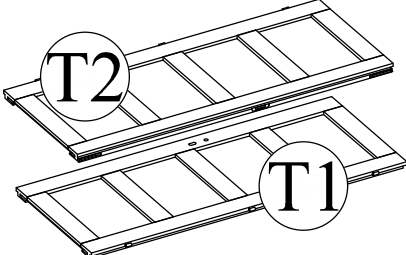
Maße, Dim., Dim.	Skizze, dessin, sketch	Pos.	Länge, longueur, Length	Menge, quantité, quantity	Name, nom, name.
		①	2800	2	Fundamentbalken Lambourdes
		②	1700	6	Foundation beam
		③	692	2	Brett für Vorderseite, Madrier avant, Front board
		④	2980	1	Brett für Rückseite, Madrier arrière, Back board
		⑤	2000	34	Brett für Seitenwand, Madrier latéral, Side board
		⑥	2980	17	Brett für Rückseite, Madrier arrière, Back board
		⑦	692	34	Brett für Vorderseite, Madrier avant, Front board
		⑧	2000	2	Brett für Vorderseite / Rückseite, Madrier avant / Madrier arrière, Front board / Back board
		⑨	2980	2	Brett für Vorderseite / Rückseite, Madrier avant / Madrier arrière, Front board / Back board
		⑩	2000	3	Sparren, Panne faîtière, Rafters
		⑪	2740	20 (16)	Bodenbrett Plancher bois Floor board
		⑫	1660	46 (36)	Dachbrett, Madrier de toit, Roof board

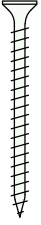
Maße, Dim., Dim.	Skizze, dessin, sketch	Pos.	Länge, longueur, Length	Menge, quantité, quantity	Name, nom, name.
		13	1700	4	Windbrett, Planche de rive, Wind board
		14	1700	4	Dachlatte, Latte de toit, Roof lath
		15	1000	4	Dachlatte, Latte de toit, Roof lath
		16	1000	4	Dachlatte, Latte de toit, Roof lath
		17	2750	1	Bodenleiste Lame de plancher Skirting board
		18	1770	2	
		19	555	2	
		20	200	2	Decor
	TR1	1960	1	Türrahmen links, Cadre de porte gauche, Door frame left	
	TR2	1960	1	Türrahmen rechts, Cadre de porte droite Door frame right	
	TR3	1580	1	Türrahmen oben, Montant supérieur, Door frame top	
	TR4	1510	1	Türstufe, Latte de finition bas Door frame bottom	
	T1	1850x 765	1	Tür, Porte, Doors	
	T2	1850x 765	1	Tür, Porte, Doors	

Skizze, dessin, sketch	Maße, Dim., Dim.	Menge, quantité, quantity
	Ø3.5 x 40	71
	Ø5.0 x 100	20
	Ø2.0 x 40	138
	Ø2.0 x 50	120

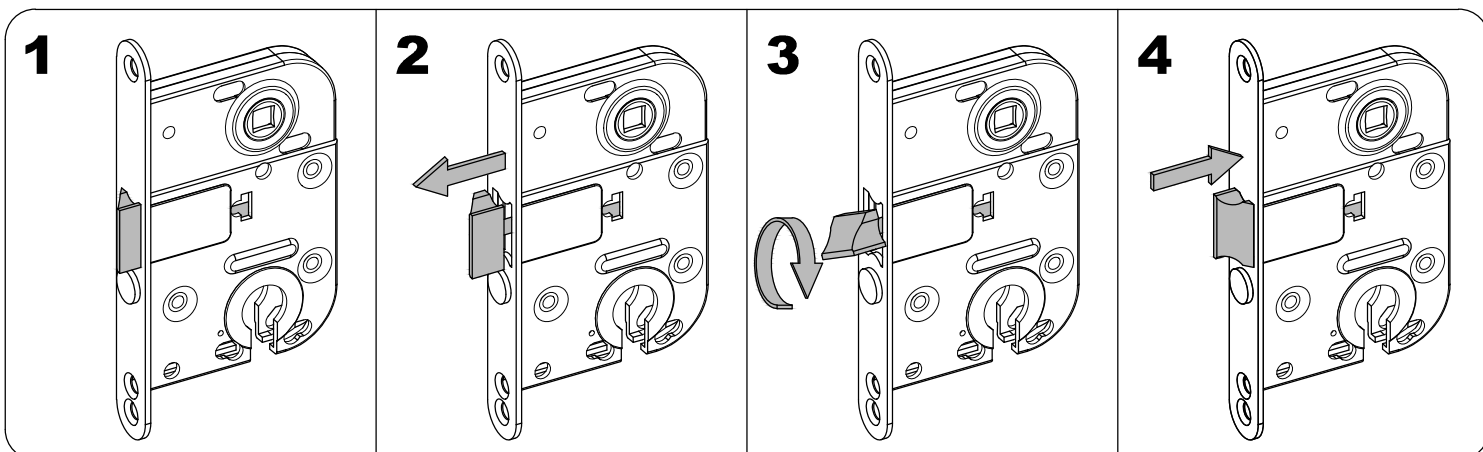
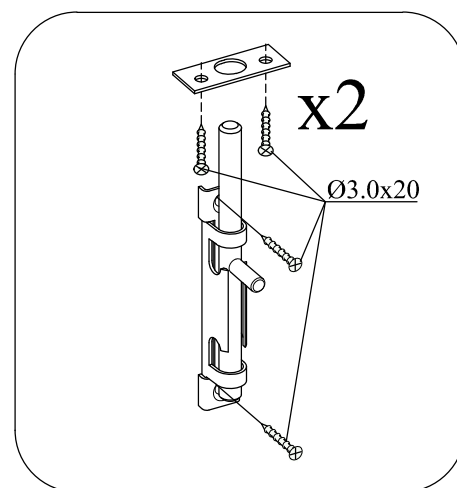
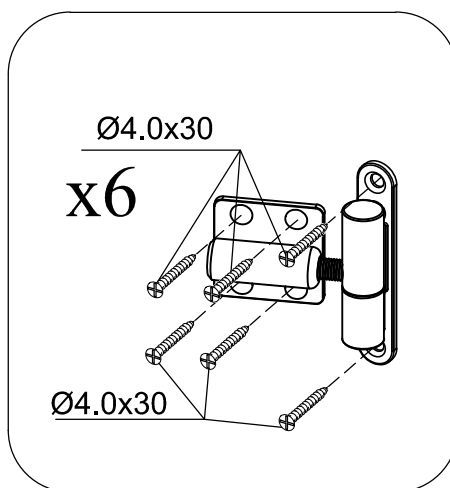
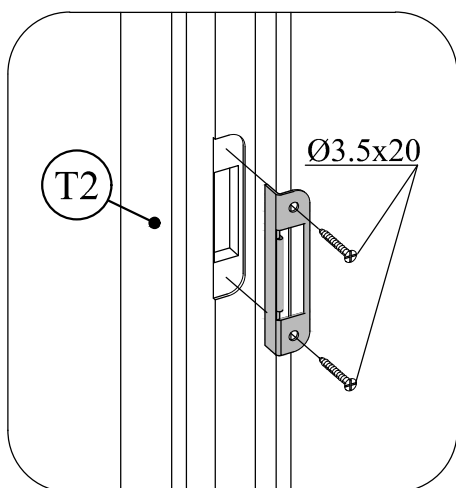
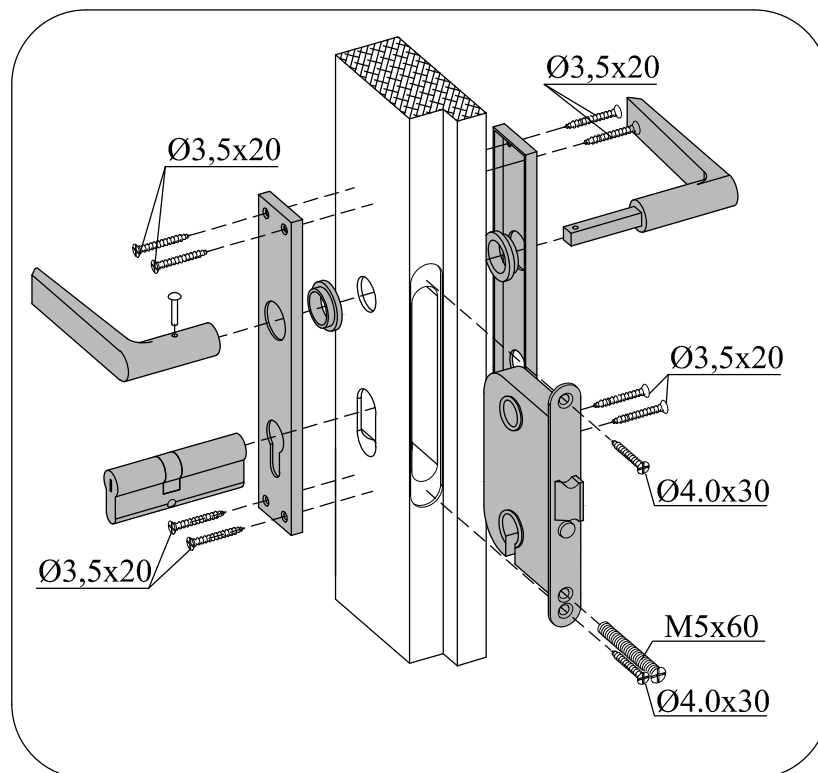

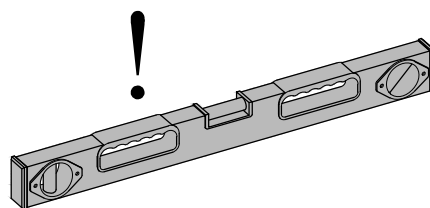
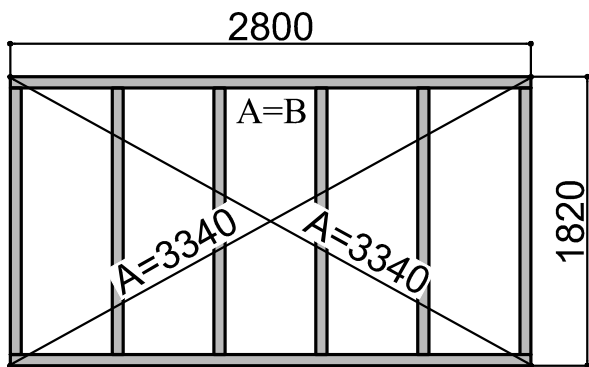

1

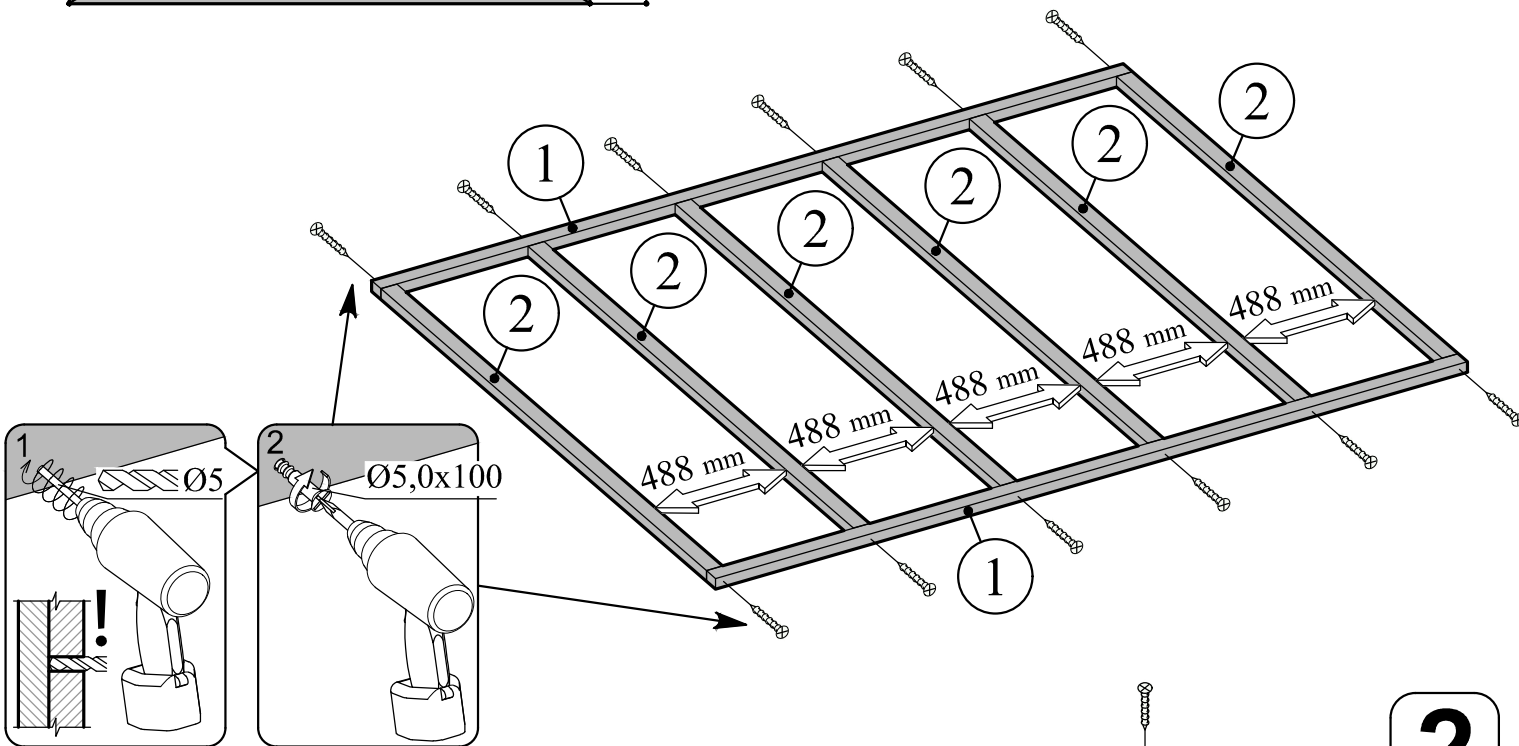

2

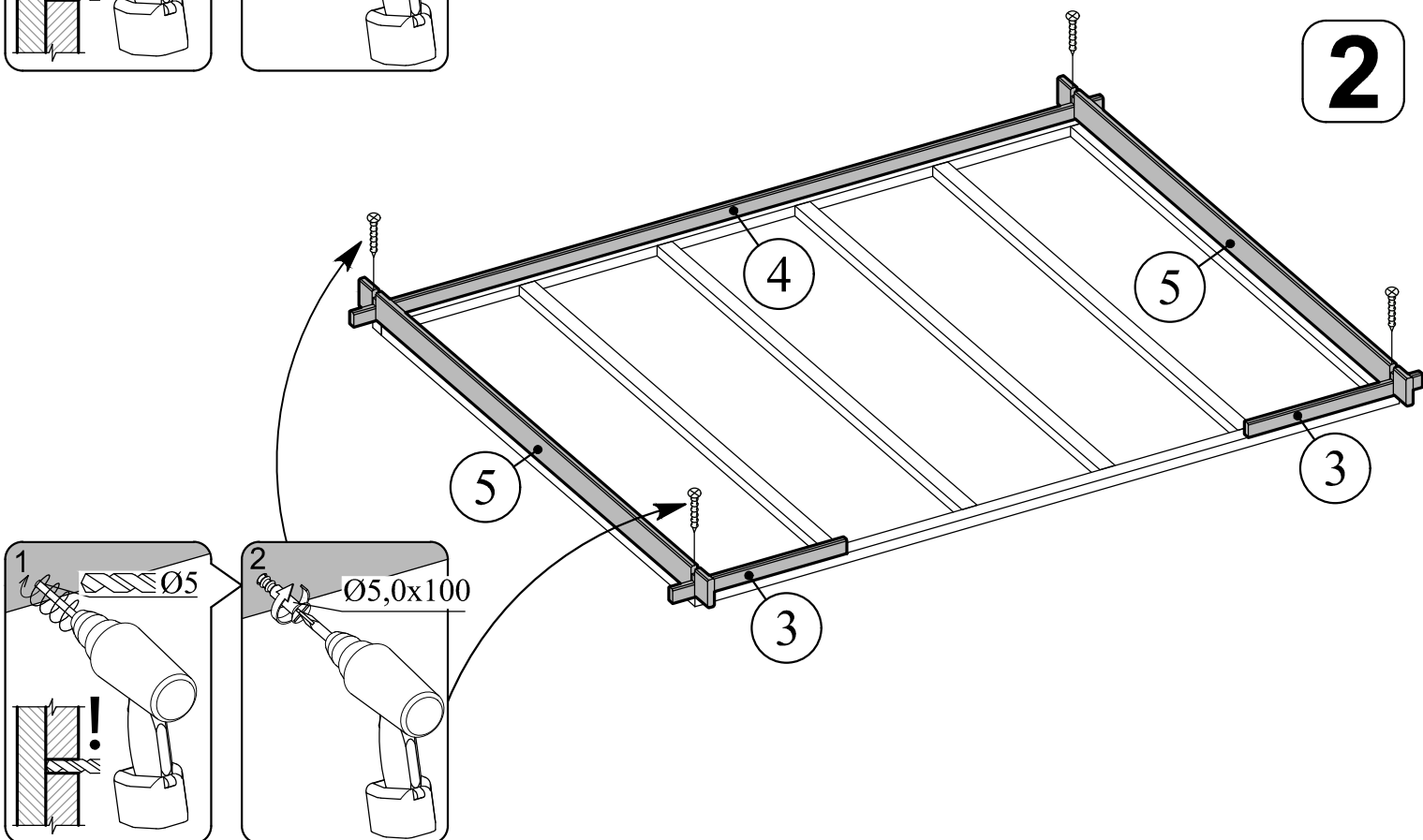

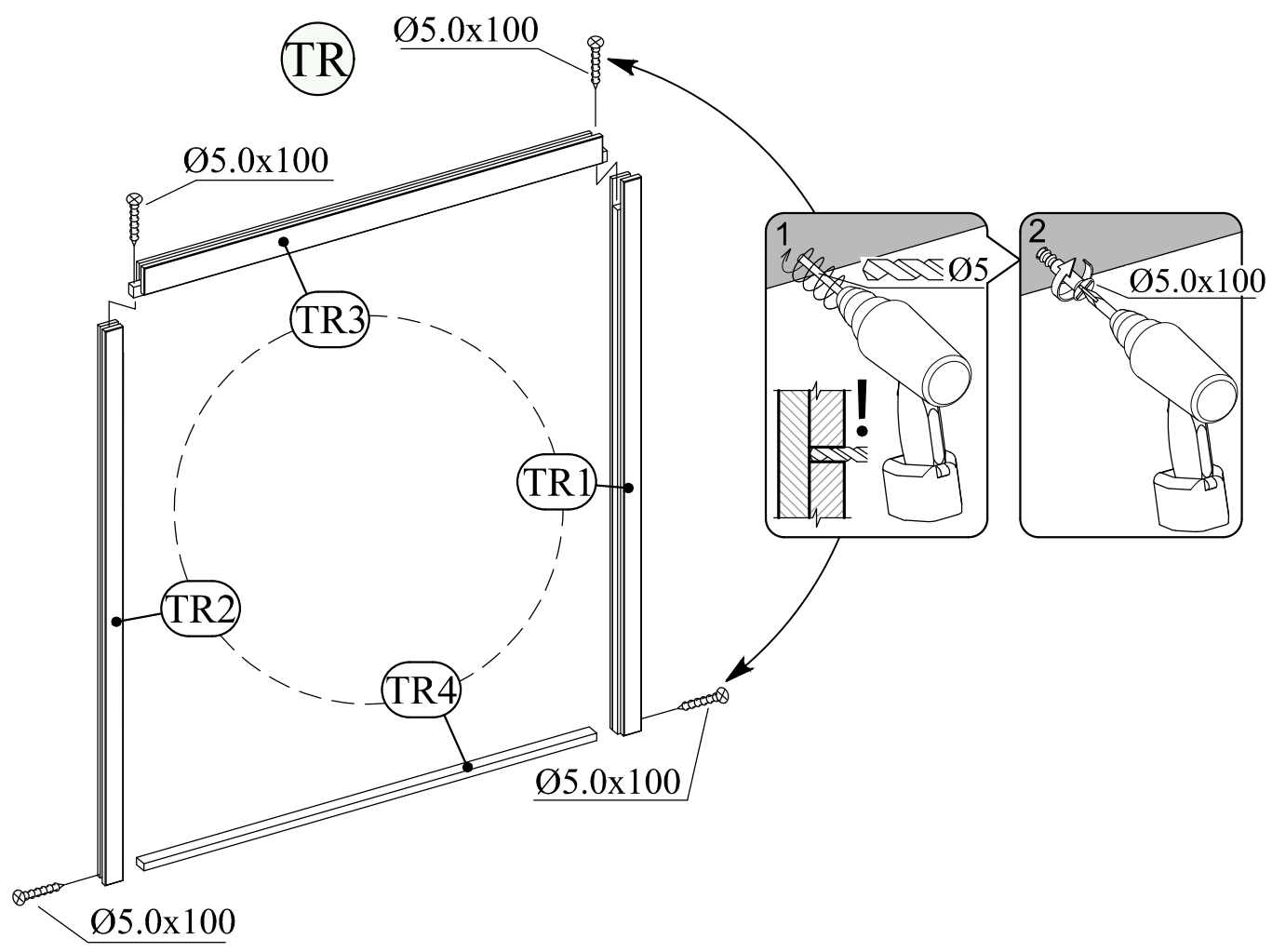
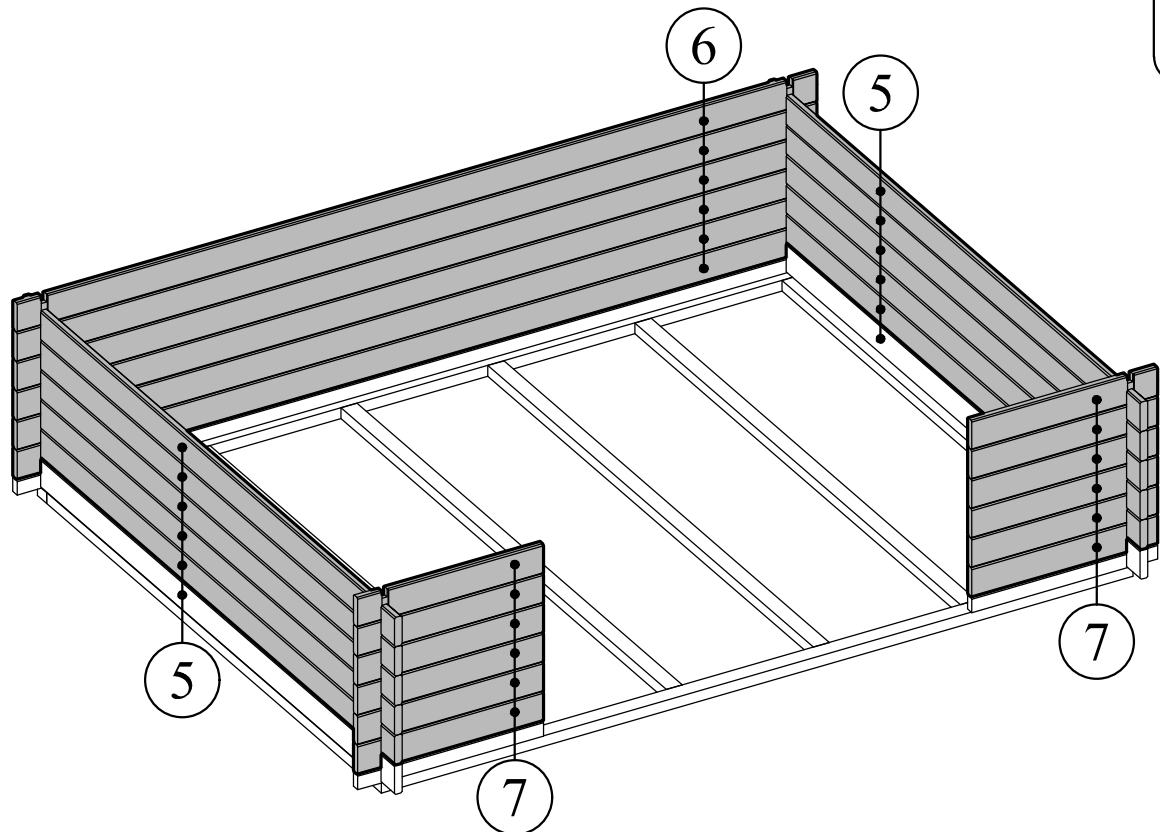
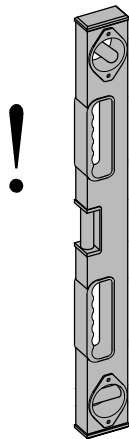

4

TR

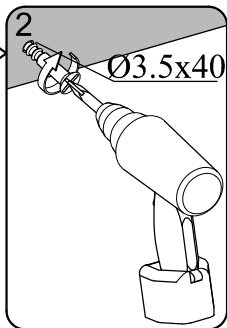
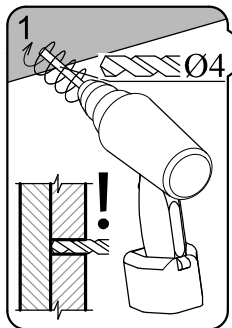
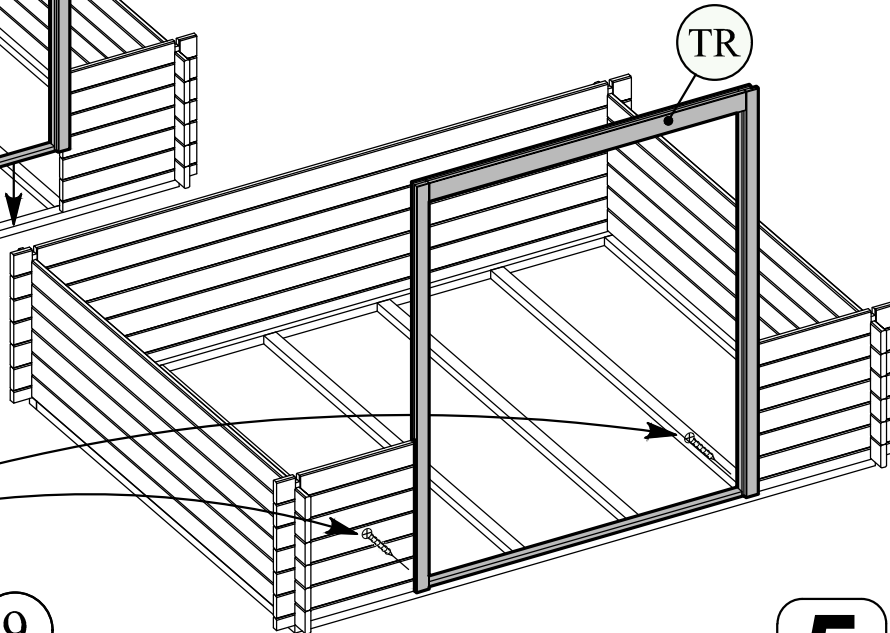
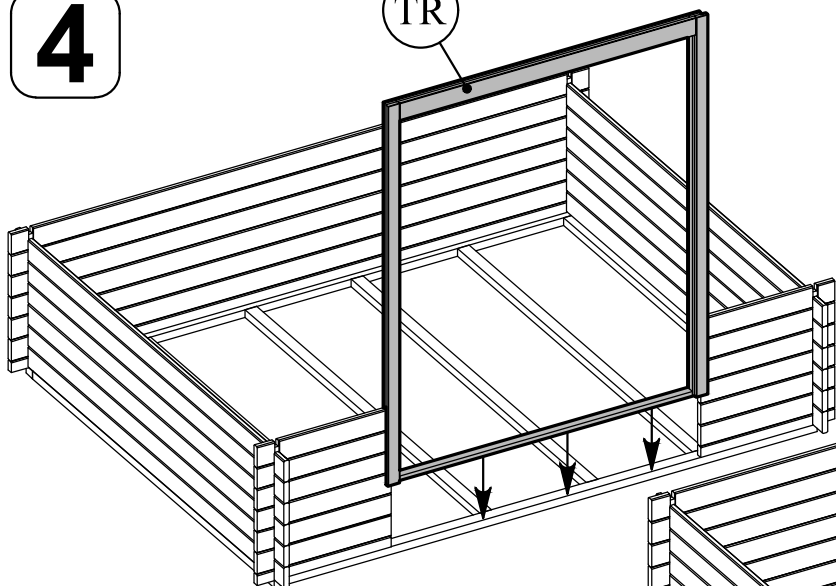

5

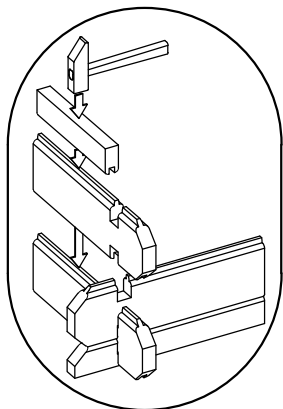
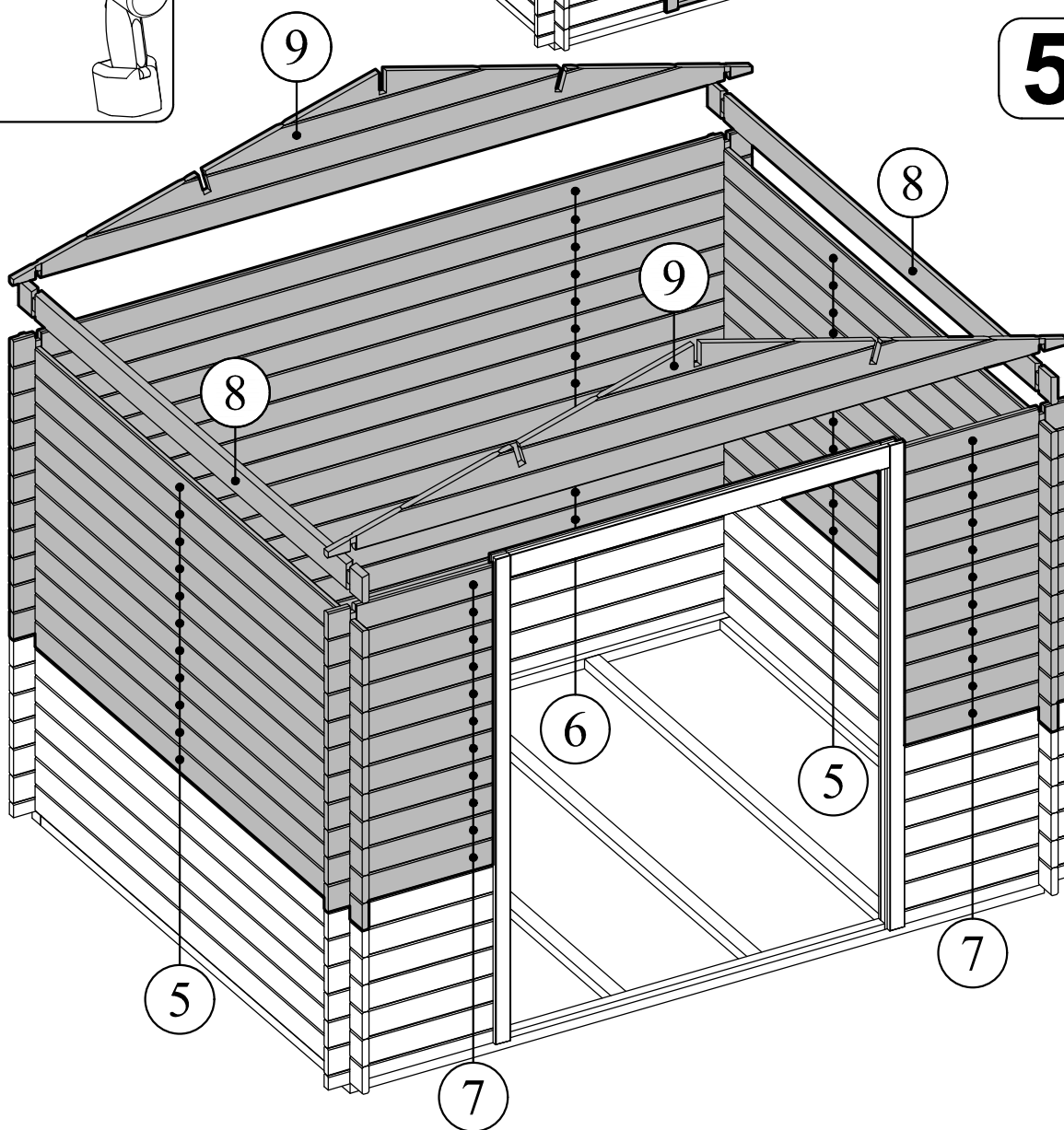

6

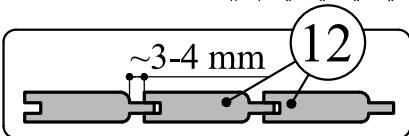
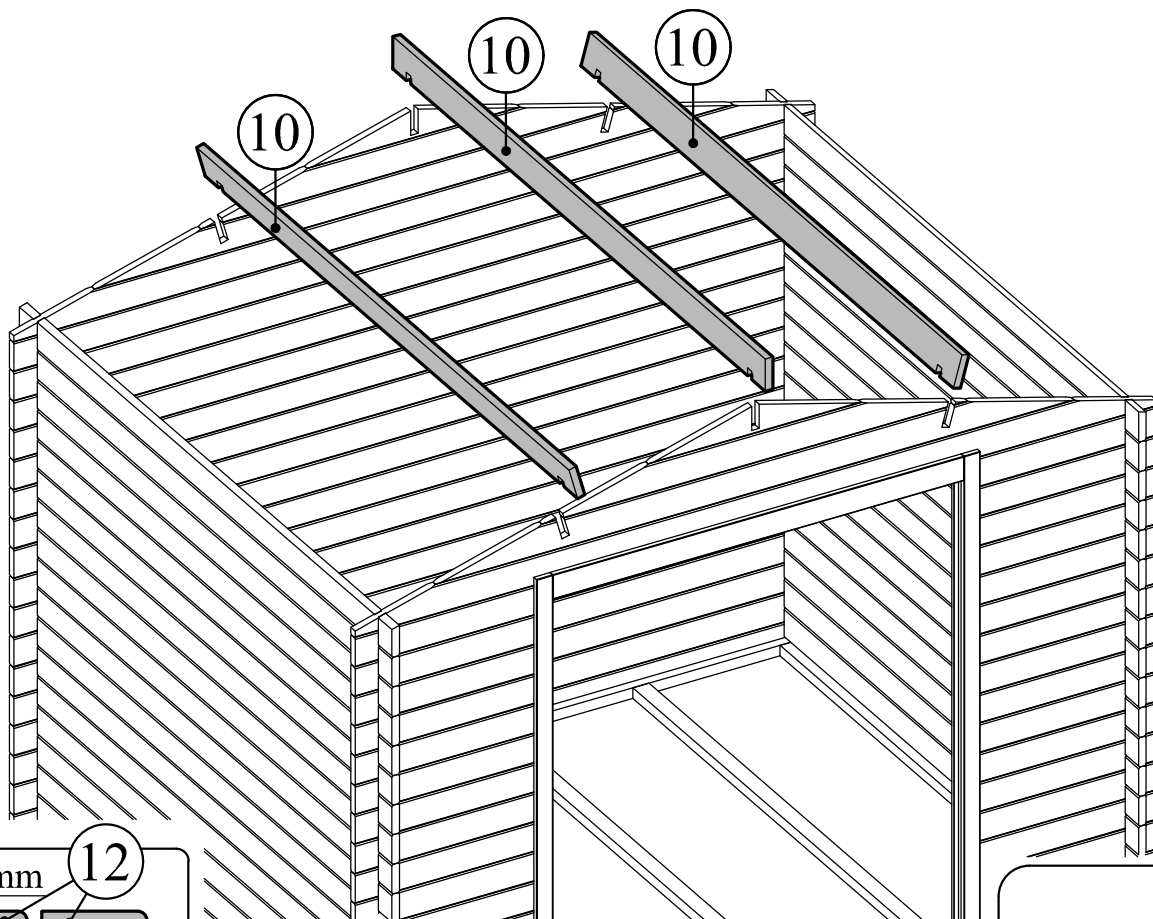

7

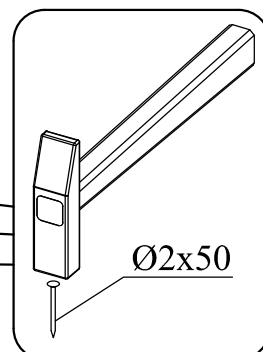
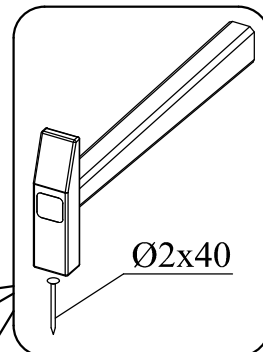
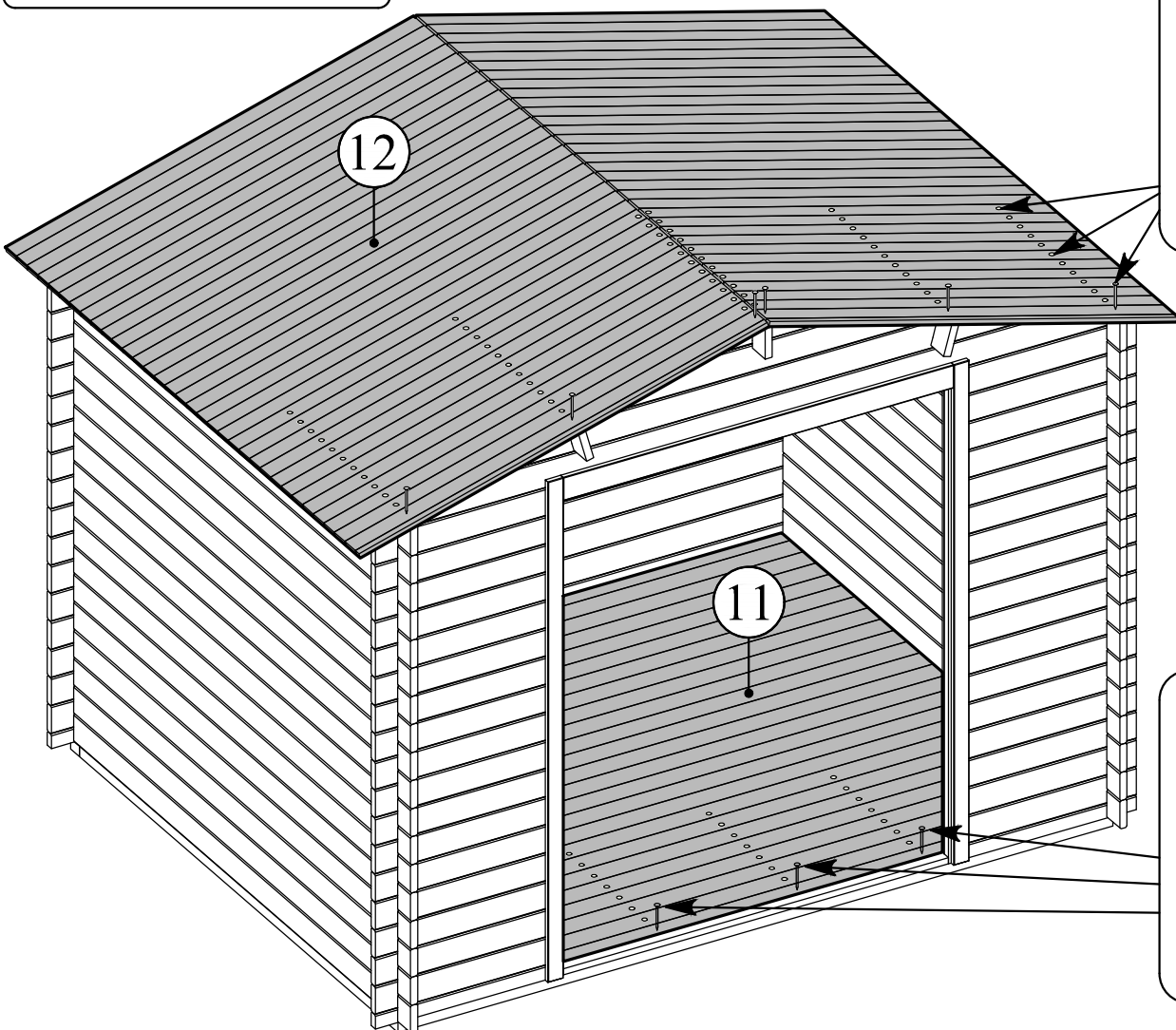

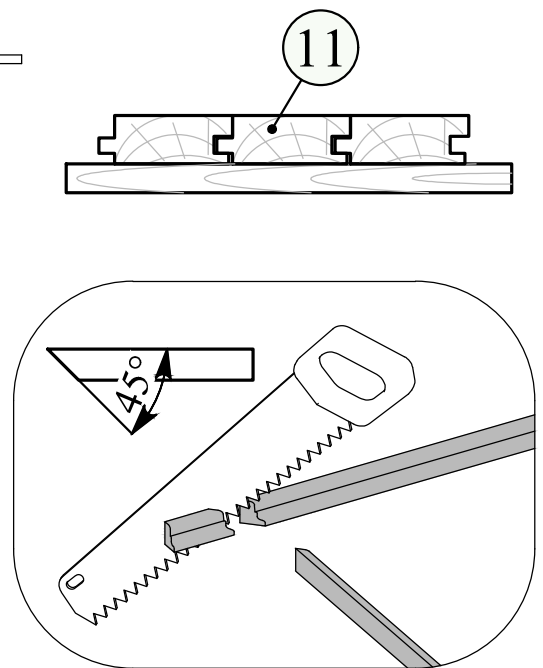
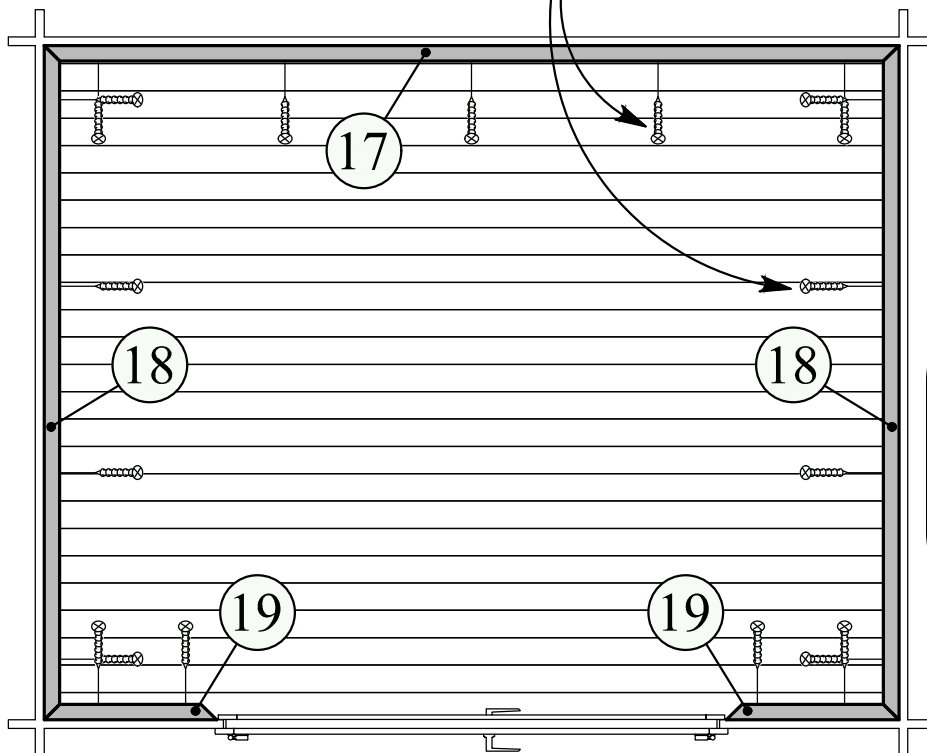
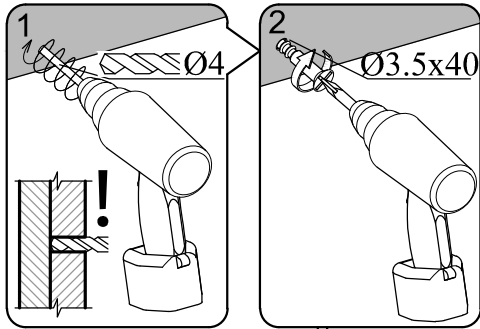
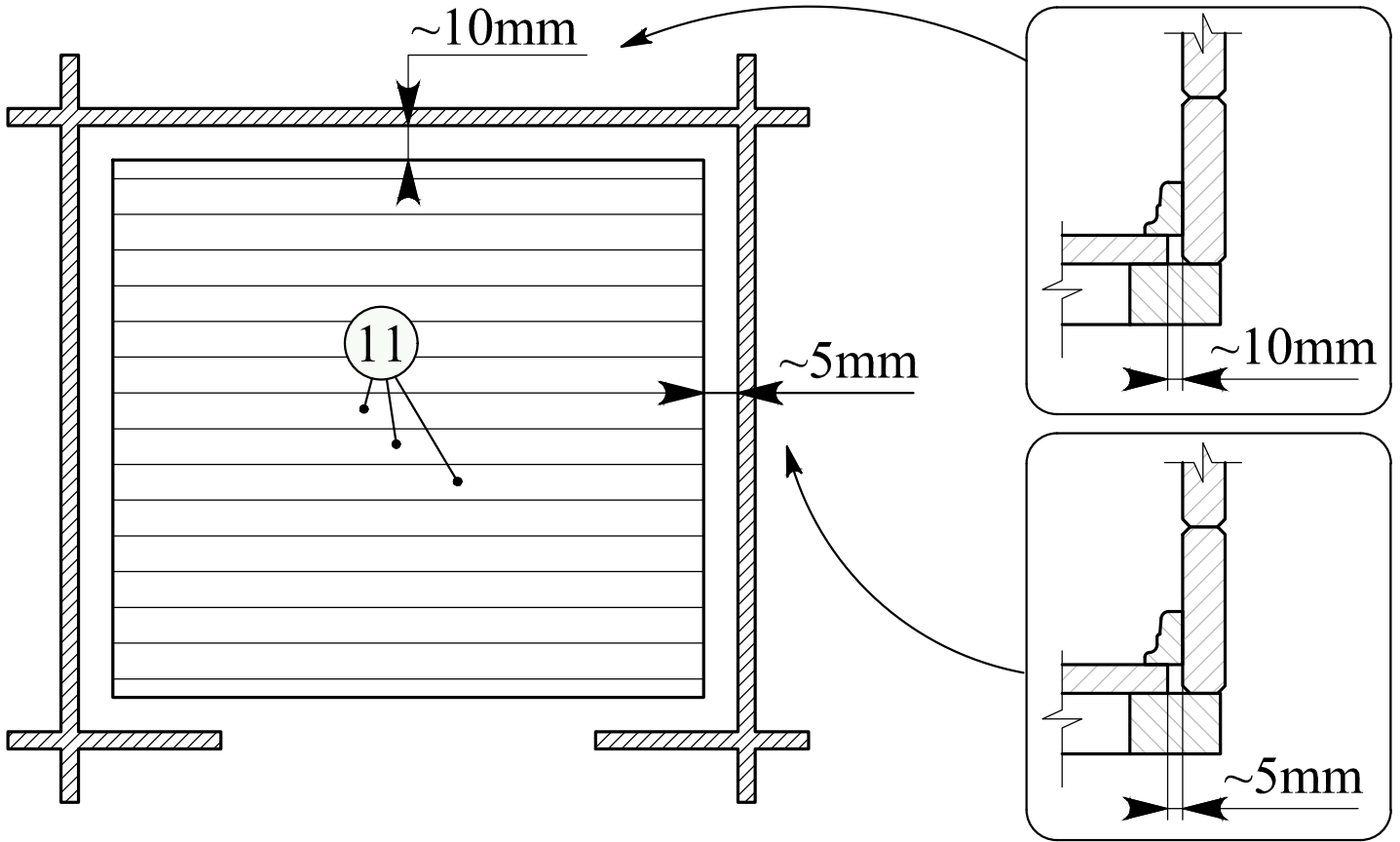

8

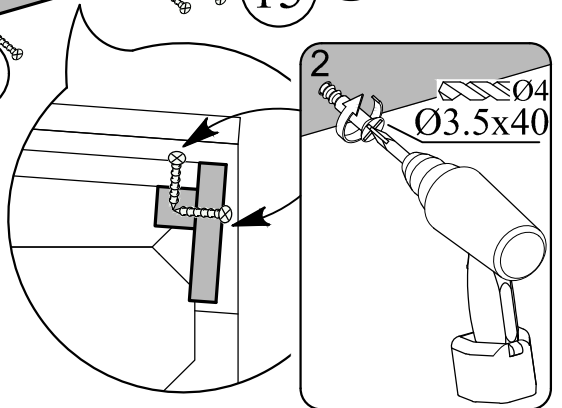
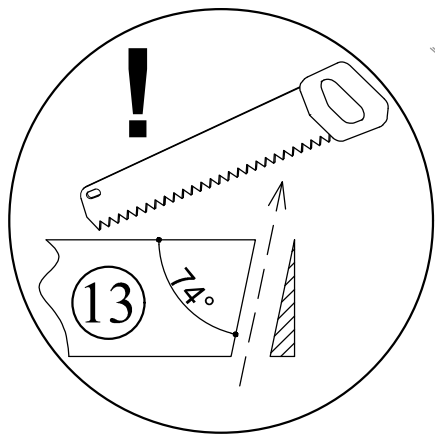
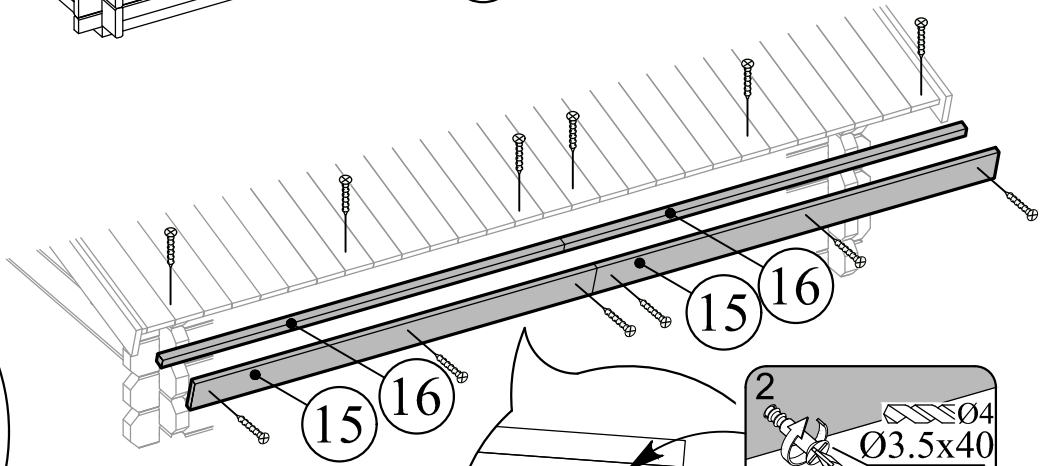
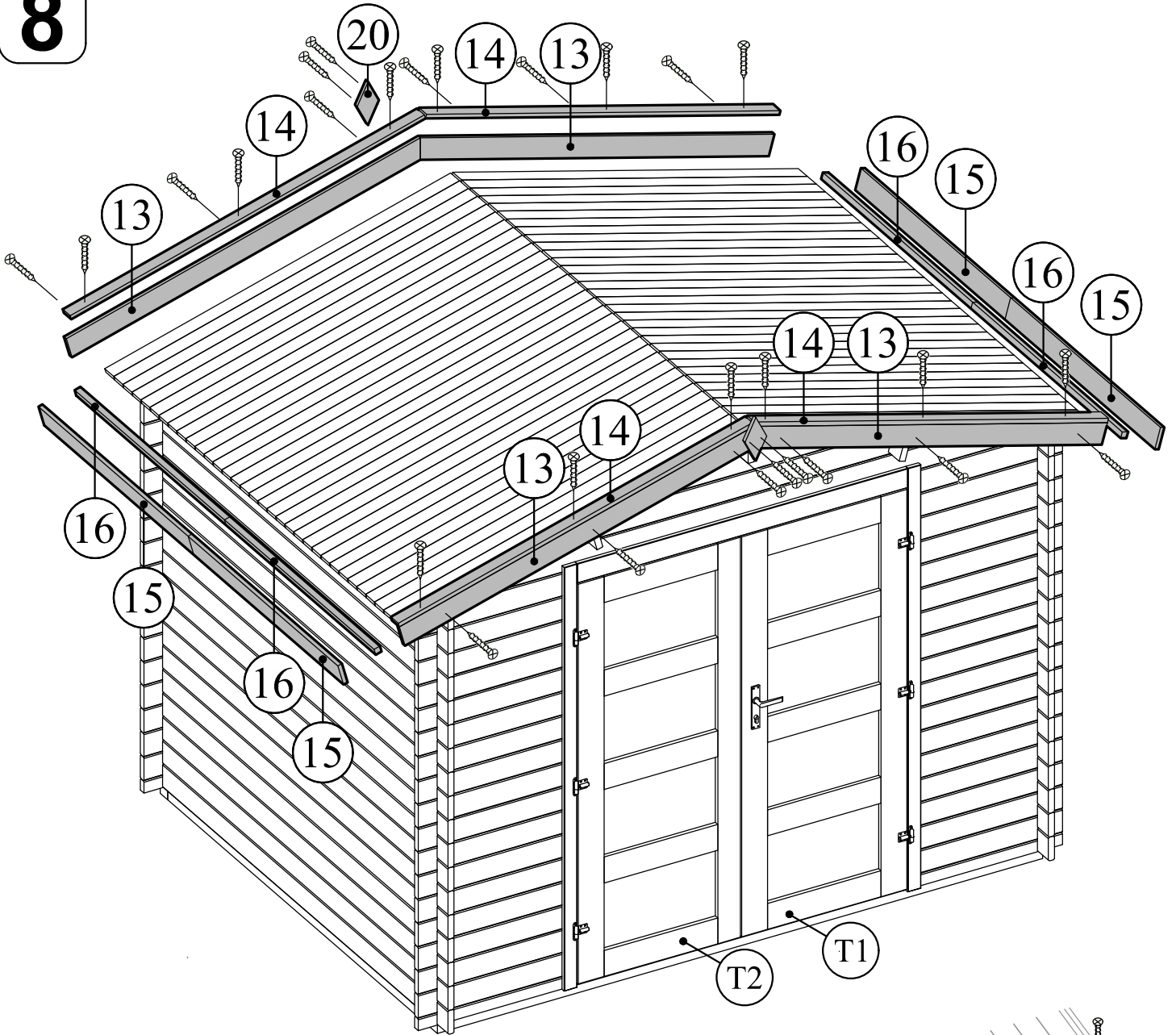

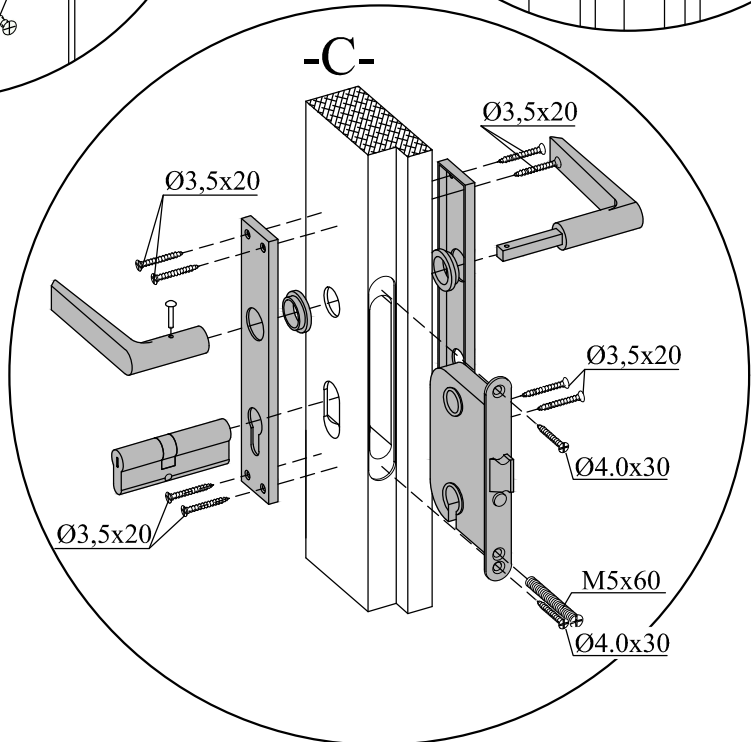
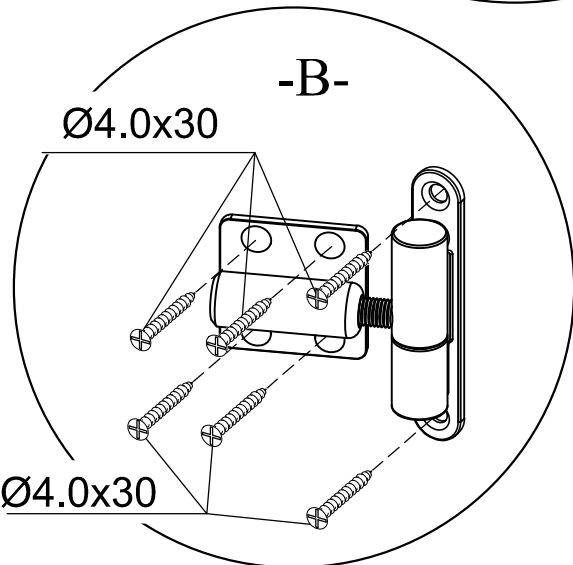
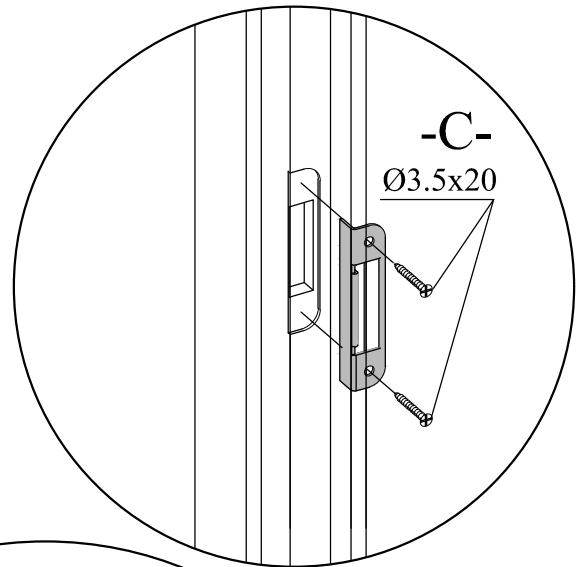
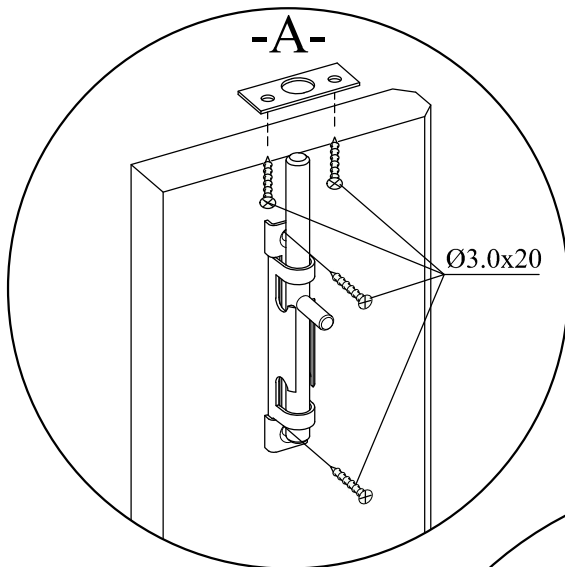
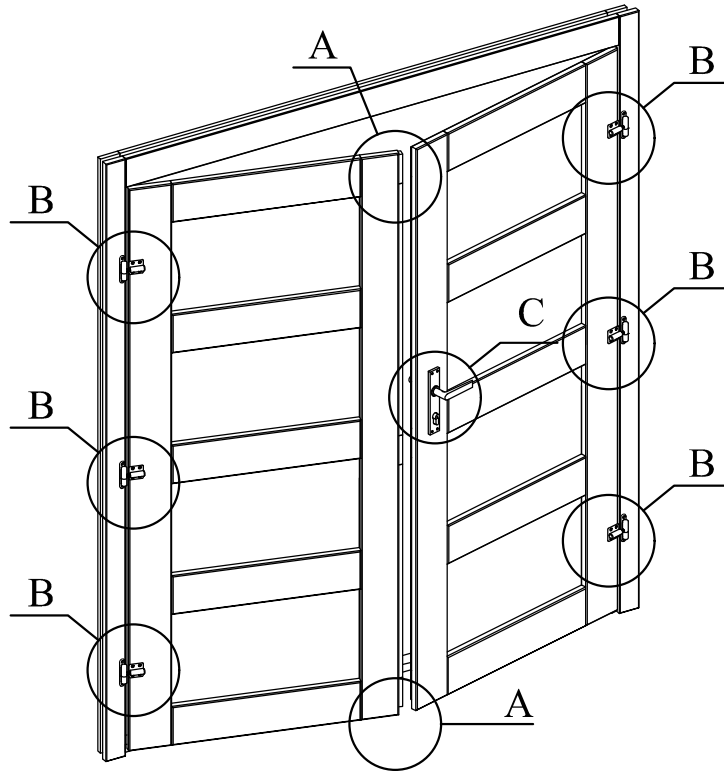

-B-

-1-

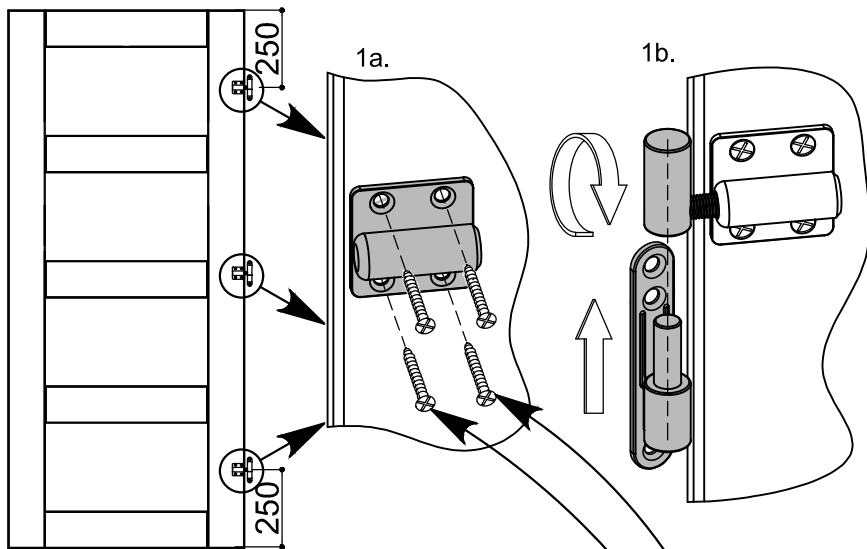
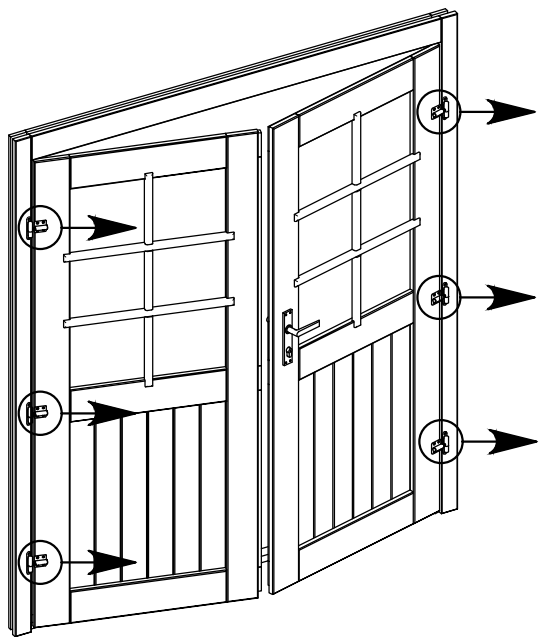

-2-

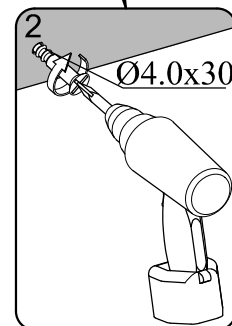
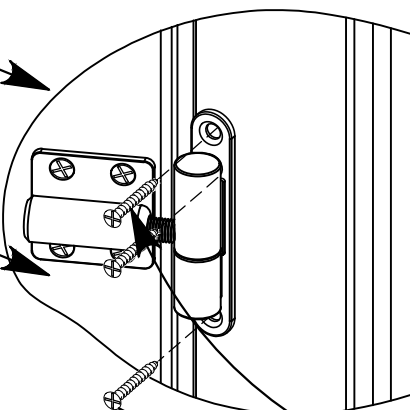
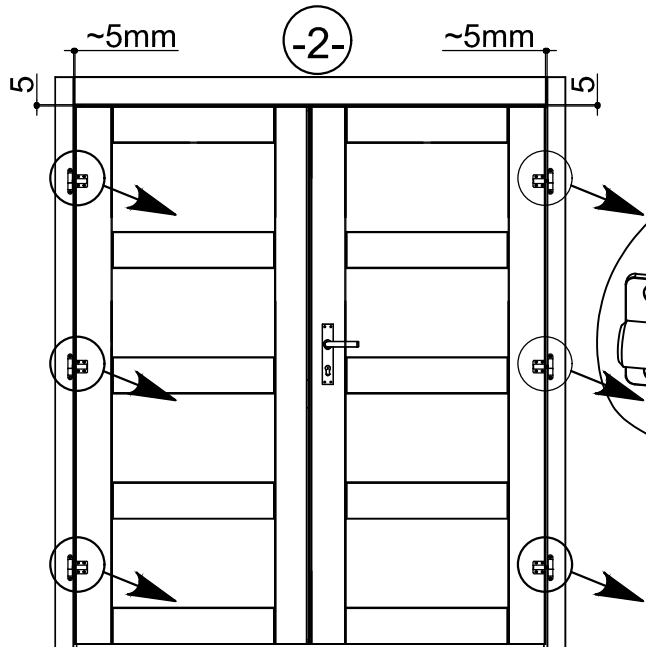

-3-

